

# SLAM200E

Handheld Laser Scanner  
Product Manual

202508

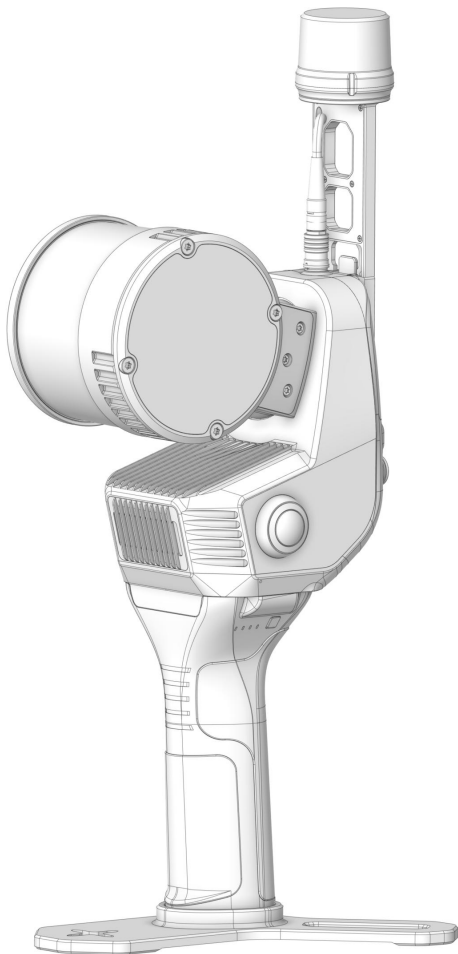

**Shenzhen Feima Robotics Co., Ltd.**

# Catalog

Disclaimer and Warning .....	3
Tips .....	5
Product Introduction .....	7
Product Overview .....	7
Supporting Software .....	8
Part Introduction .....	8
System Parameters .....	11
Product Usage .....	13
SLAM200E Operating Process .....	13
Device Assembly .....	14
Equipment Recovery .....	19
Indicator Introduction .....	21
Battery Charging .....	25
Battery Charger .....	25
Charge Method .....	25
Power Supply .....	26
Data Storage .....	30
Device Activation .....	30
Data Collection .....	31
Device Power-On .....	31
Start Data Collection .....	32
Control Point Collection .....	32
Stop Data Collection .....	34
Power Off the Device .....	34
Data Check .....	34
SLAM GO Operating Instructions .....	35
Overview .....	35

---

SLAM GO Registration and Login .....	38
Personal Center .....	41
Device Connection Status .....	51
Device Operation .....	54
Project Management .....	63
Diagnosis and Feedback .....	68
Data Collection Guidance .....	70
Site Inspection .....	70
Closed Loop .....	72
Typical Environmental Data Collection Considerations .....	72
Caution .....	76
Storage Requirement .....	77
Contact Us .....	78

---

## Disclaimer and Warning

Thank you for purchasing the SLAM200E product. The content mentioned in this document pertains to your safety as well as your legal rights and responsibilities. Please read this document carefully before using the product to ensure proper setup and operation. Failure to follow the instructions and warnings in this document may result in harm to yourself or others, damage to the SLAM200E, or harm to other surrounding objects. The final interpretation rights for this document and all related SLAM200E documents belong to Shenzhen Feima Robotics Co., Ltd. (hereinafter referred to as "Feima Robotics"). Updates may be made without prior notice.

By using this product, you are deemed to have carefully read, understood, acknowledged, and accepted all terms and content of this disclaimer and warning. You agree to take full responsibility for the use of this product and any consequences that may arise. You also agree to use this product solely for legitimate purposes and comply with these terms as well as any applicable regulations, policies, and guidelines established by Feima Robotics.

Except as required by applicable laws and regulations in China, Feima Robotics is not liable for any direct or indirect losses, injuries, or legal responsibilities arising from the use of the product or related materials. Users must adhere to all safety guidelines mentioned, including but not limited to those specified in this document.

Feima Robotics reserves the right to modify this product manual and product specifications. For the latest version of the product manual, please visit [www.feimarobotics.com](http://www.feimarobotics.com).



This trademark belongs to Shenzhen Feima Robotics Co., Ltd. and its affiliated companies. The product names and brands mentioned in this document are trademarks or registered trademarks of their respective companies.

## Tips

Tips: —Important content of special reminders.

Notice! — Important elements that may cause damage to the equipment if operated incorrectly.

 Warning — Important content. The wrong operation may cause equipment damage or even personal injury.

### Warning

- Operators should always pay attention to the surrounding environment when collecting data to avoid safety accidents caused by distractions.
- SLAM200E does not have explosion-proof attributes, and is strictly prohibited to be used near gas stations or in dangerous scenes such as mines, pits, septic tanks, etc. where gas, natural gas, methane, and other flammable and explosive gases gather.
- To avoid fire, property damage and personal injury, use the battery, charging and storage process must follow the guidelines in this manual.

### Notice!

- The SLAM200E is a high-precision control device. Dropping or any impact may cause damage to the SLAM200E, resulting in malfunction.
- Ensure that after the SLAM200E is powered on, the gimbal rotates freely without any external force obstruction.
- After transferring data from the SLAM200E to a computer, please “Safely Remove Hardware” before disconnecting the USB cable.
- To power off the SLAM200E device, please use the power button. Do not remove the battery handle or disconnect the power source (such as USB-PD) while the device is powered on.
- During use of the SLAM200E, please ensure protection against dust and sand.

- When using the SLAM200E, protect the laser and camera lens from scratches caused by hard objects.
- The splash-proof, water-resistant, and dustproof features are not permanently effective. Protective performance may decrease with normal wear, and liquid damage is not covered under warranty.
- To prevent liquid damage, please avoid the following actions:
- ① Placing the SLAM200E in high-pressure or high-flow water, or intentionally submerging it in water.
- ② Dropping the SLAM200E onto the ground or subjecting it to other impacts.
- ③ Disassembling the SLAM200E, including unscrewing any screws.

---

## Product Introduction

### Product Overview

The SLAM200E is Feima Robotics' meticulously developed third-generation high-precision handheld 3D laser scanner.

Equipped with either a 16-line or 32-line high-performance LiDAR sensor, dual 12-megapixel panoramic cameras, an integrated high-precision GNSS module, and an upgraded processing unit, the SLAM200E delivers a brand-new experience in spatial data acquisition.

Paired with SLAM GO APP and SLAM GO POST Pro post-processing software, the device features a self-developed SLAM mapping algorithm and colorization algorithm with major upgrades, enabling real-time colored point cloud generation. These enhancements not only significantly improve mapping accuracy and operational efficiency, but also allow users to easily obtain high-density, ultra-detailed, and richly colored 3D point cloud results.

As the successor to its previous two generations, the SLAM200E not only inherits the outstanding performance of its predecessors, but also achieves a qualitative leap in accuracy, detail capture, colorization, and ease of operation. Its exceptional performance and innovative design make it a new benchmark in the surveying industry, driving the future of spatial data acquisition technology.

## Supporting Software

### SLAM GO POST Pro

A PC-based data processing software that enables one-click SLAM mapping, coordinate transformation, and point cloud coloring. It also supports point cloud browsing, editing, data exploration, and measurements.

### SLAM GO

A mobile app compatible with Android and iOS systems, offering features such as device parameter configuration, real-time mapping data visualization, firmware upgrades, and maintenance.

## Part Introduction

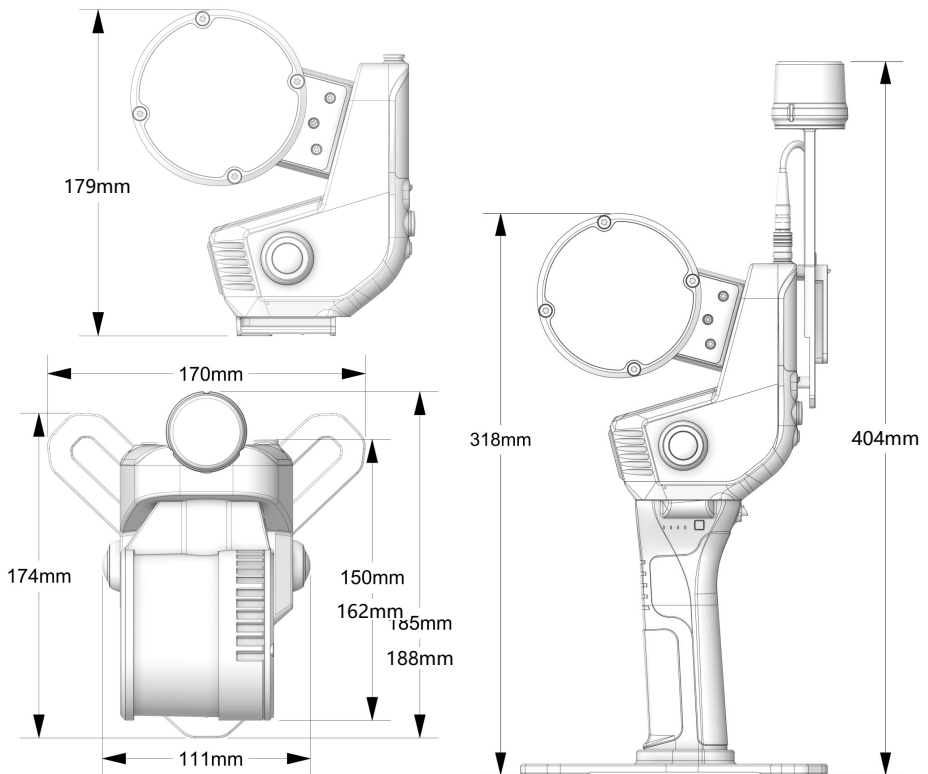

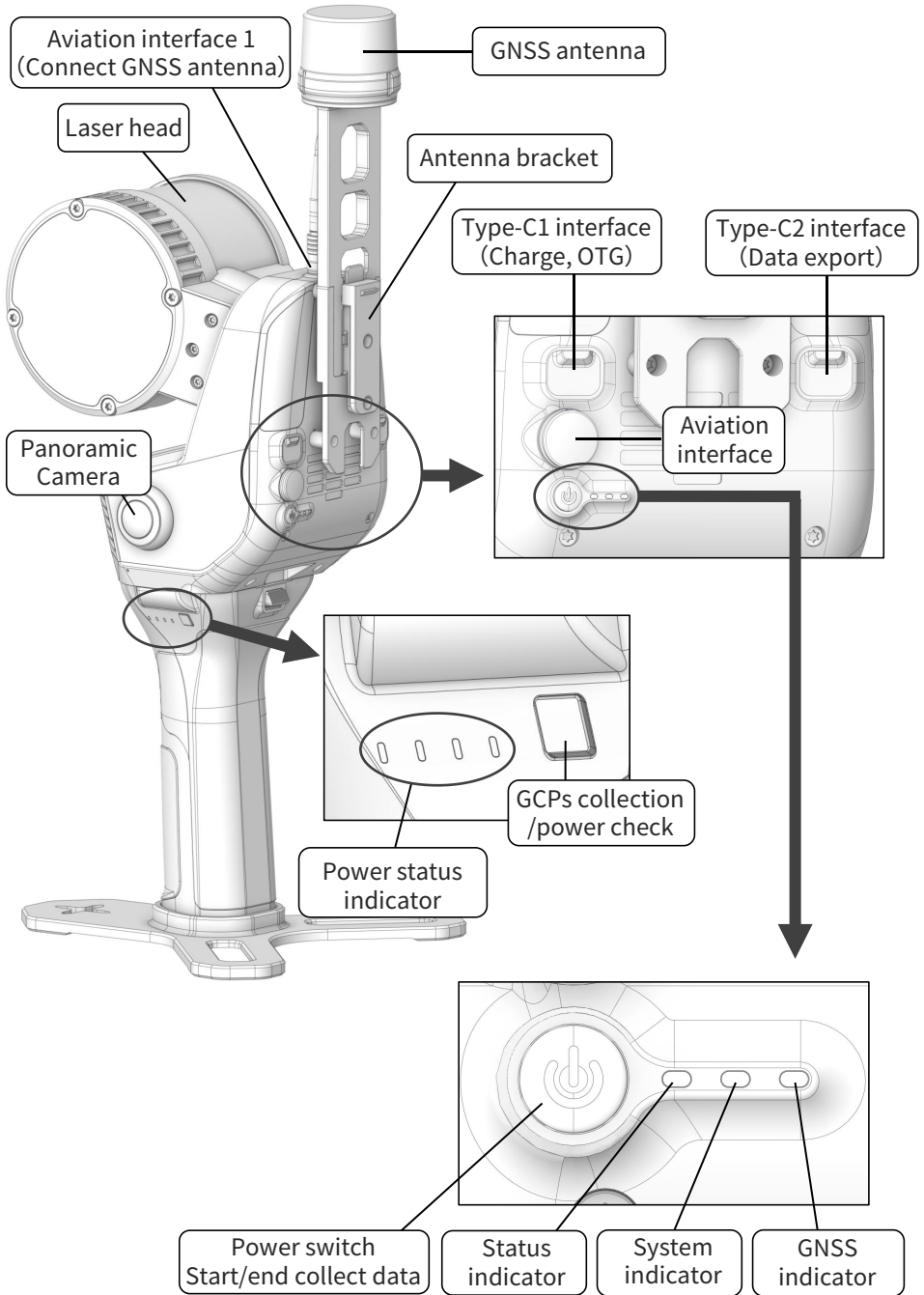

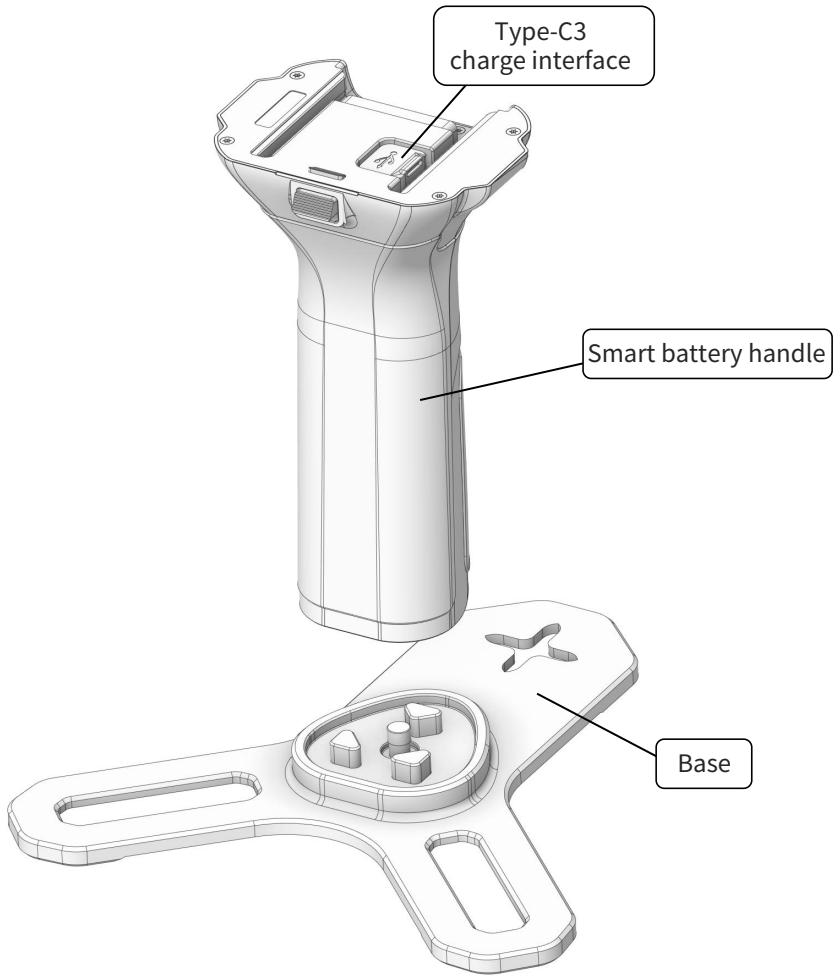

## System Parameters

SLAM200E

Part	Names	Parameter
Total	Model	SLAM200E
	Weight	1.6kg (body) 2.1kg (including handle, base, excluding antenna bracket)
	Dimensions	Length × Width × Height (body): 162mm×111mm×179mm
		Length × Width × Height (including handle, base, antenna): 188mm×170mm×404mm
	Power Consumption	26W (typical)
	Aviation Plug 2 Input Voltage	20V (specified )
	Type-C1 Input Voltage	20V (PD rated)
	Storage Capacity	512GB SSD
	Operating Temperature	-20°C~+50°C
	Storage Temperature	-40°C~+70°C
	Operating Humidity	<95%
	Protection Rating	IP54
	Operating Mode	Mobile, Static, Airborne, Vehicle-mounted
	Result Accuracy	Relative Accuracy 5mm@60m Absolute Accuracy 2cm (typical)
Laser	Laser Wavelength	905nm
	Eye Safety Class	Class 1

	Max Scanning Range	120m (@100klx)
	FOV	270° × 360°
	Point Frequency	320kPts/640kPts
	Echo	8bits
	Point Cloud Frame Rate	10Hz (typical value)
Panasonic Camera	Resolution	12 million pixels × 2
	Diagonal Field of View (FOV)	210° (Single Camera)
Interaction	Type-C 1	Charging (Power Supply) + OTG
	Type-C 2	SSD storage
	Navigation Connector 1	GNSS Antenna Connection
	Navigation Connector 2	Power Supply
	WiFi	Supported
	Bluetooth	Supported
Smart Battery	Model	SP30
	Charging Interface	Type-C3
	Input Voltage	5-20V
	Output Voltage	10.8V
	Battery Capacity	3000mAh
	Compliance Standard	GB31241-2014S
	Weight	Around 400g
	Dimensions	Length × Width × Height 85 mm × 60 mm × 145mm
Endurance	70min (Only SLAM200E work)	

## Product Usage

### SLAM200E Operating Process

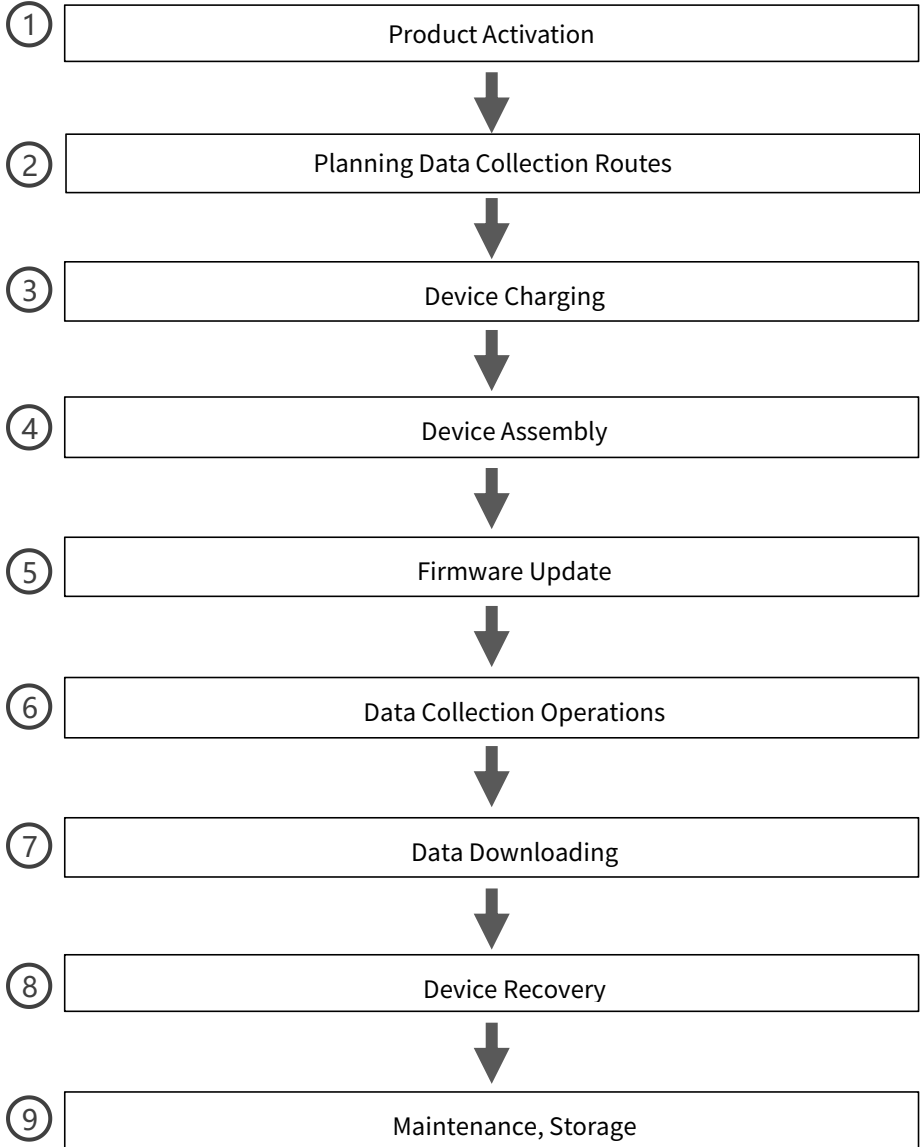

## Device Assembly

### 1 Mounting Base

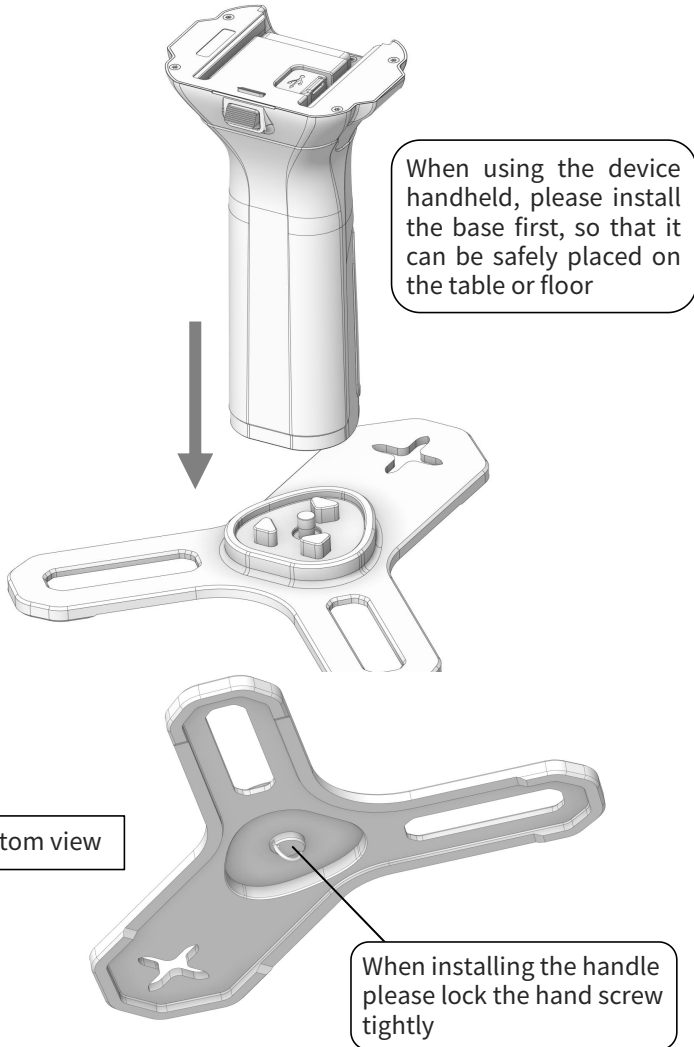

## 2 Assemble Handle

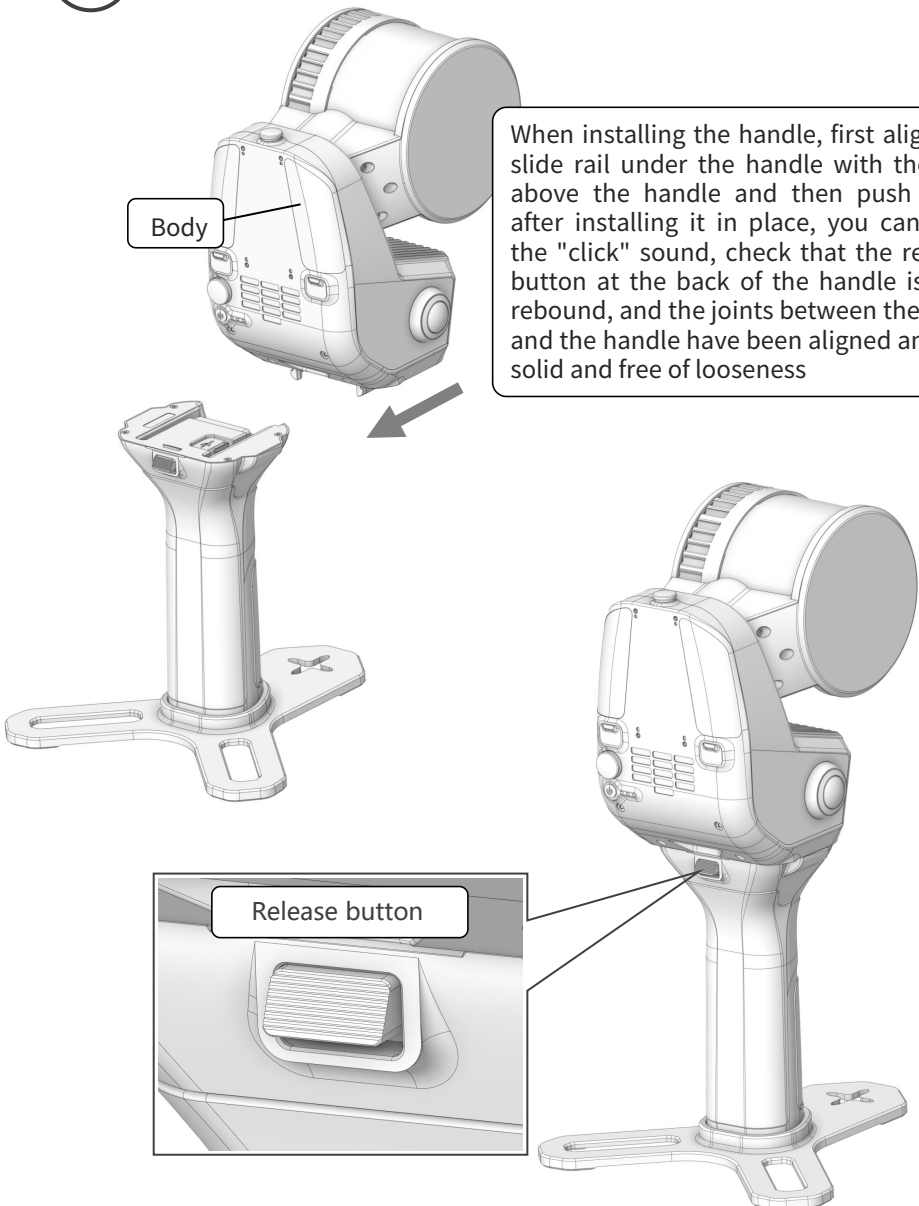

When installing the handle, first align the slide rail under the handle with the slot above the handle and then push it in, after installing it in place, you can hear the "click" sound, check that the release button at the back of the handle is fully rebound, and the joints between the body and the handle have been aligned and are solid and free of looseness

### 3 GNSS Antenna

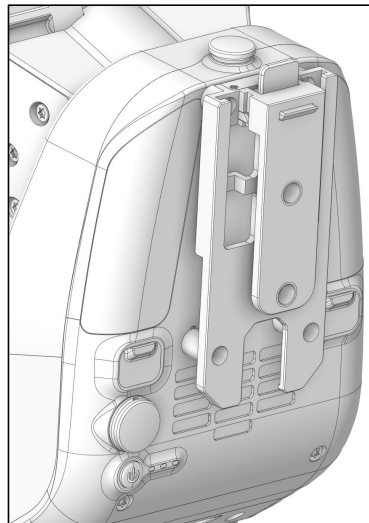
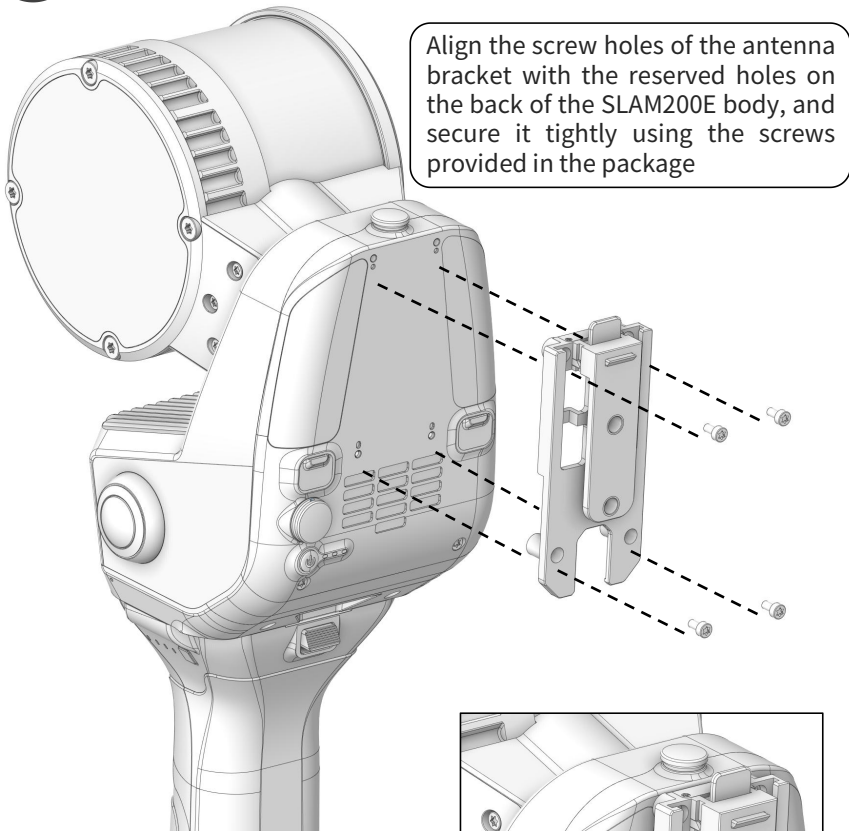

The antenna assembly has a reverse-insertion prevention design and cannot be inserted incorrectly. Before installation, confirm that the antenna direction aligns with the bracket slot. Then insert the antenna from top to bottom. After hearing a “click,” check that the antenna assembly fits snugly with the bracket and is securely installed.

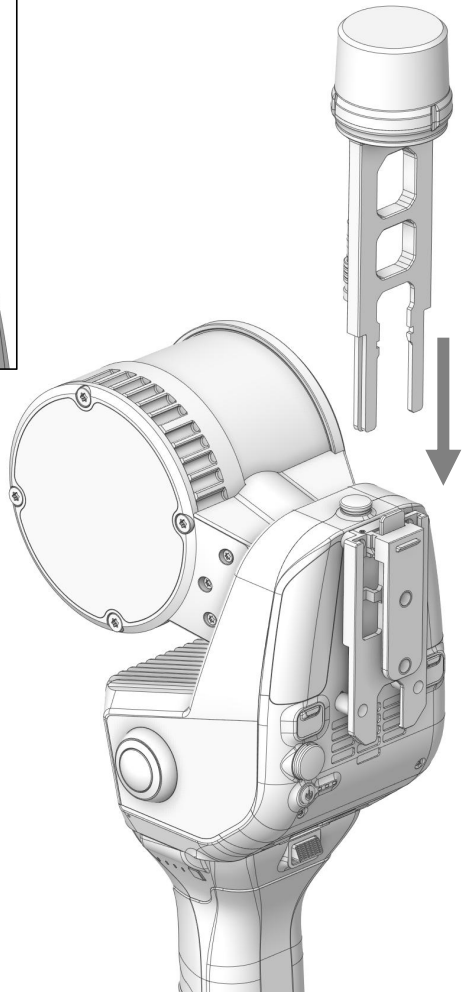
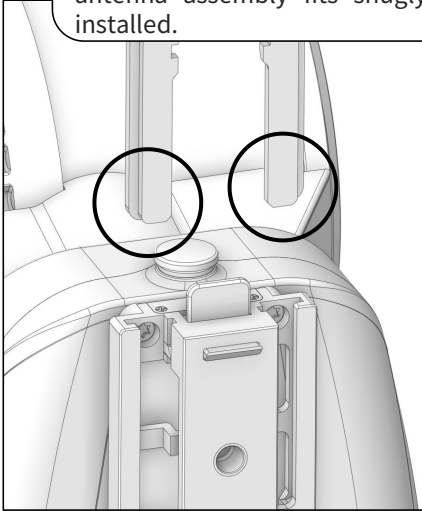

Connect the antenna feeder cable (this component may be omitted if the RTK function is not used)

Remove the dust cap from the aviation plug port on the top of the SLAM200E body. Note that the aviation plug has a reverse-insertion prevention design and a red marking, which prevents incorrect insertion. When connecting, align the red dot on the aviation plug with the red dot on the device aviation port before inserting.

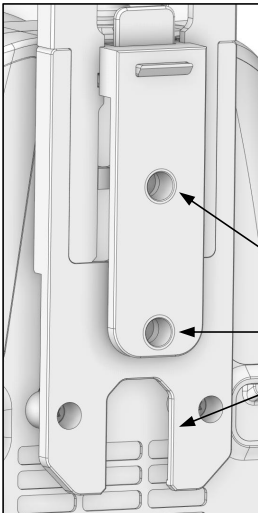
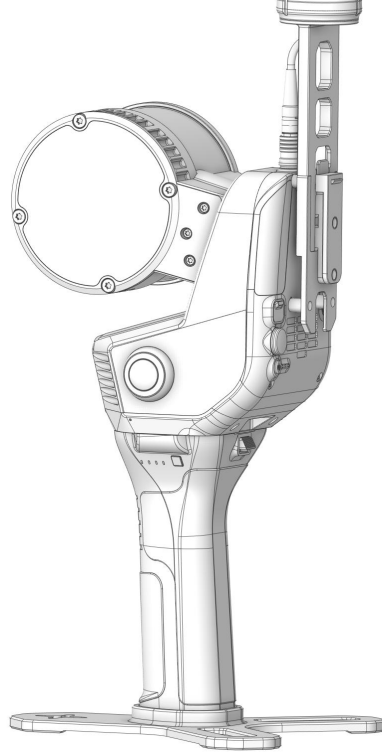
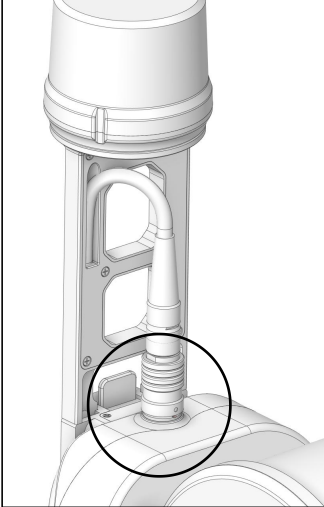

The back of the antenna bracket has two reserved 1/4-inch mounting holes (imperial UNC thread) and a multifunctional expansion slot, supporting the installation of most external phone holders.

※ The phone holder needs to be purchased separately by the user.

## Equipment Recovery

1. Before removing the antenna, disconnect the aviation plug cable from the device. Hold the metal head of the aviation plug and lift it upward to remove it smoothly. Note that this plug has an anti-disconnection design, so pulling directly on the cable will not allow the plug to be removed.
2. To remove the antenna, press the "release button" on the antenna bracket and then lift the antenna assembly upward.

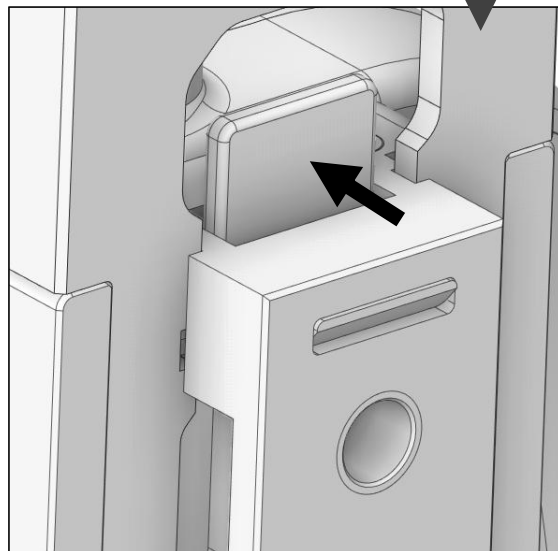
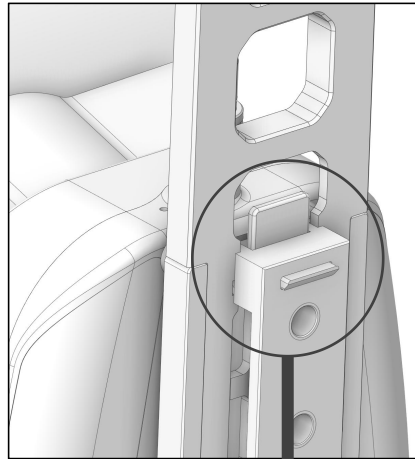
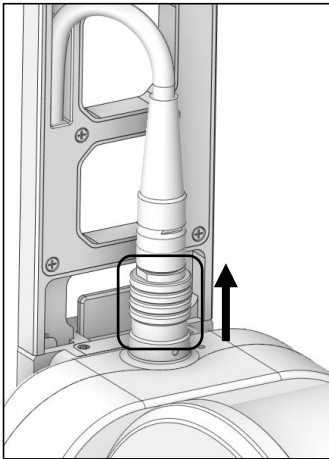

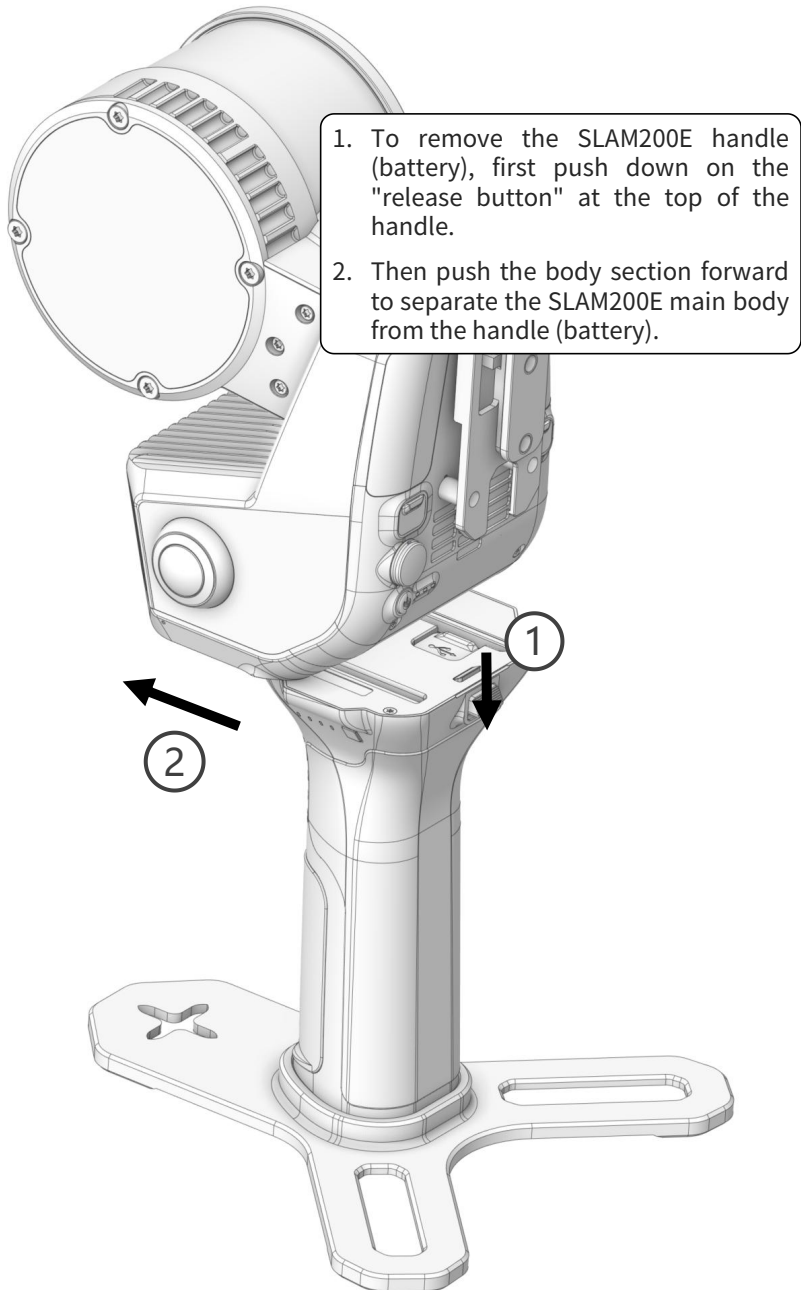

## Indicator Introduction

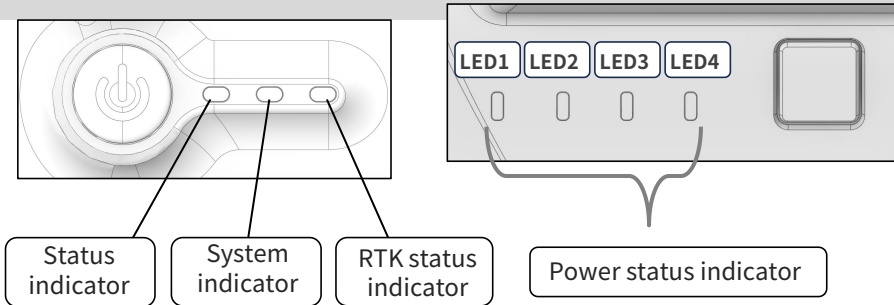

LED	Display	Introduction	
Status Indicator	White Light Fast Flashing	MCU Firmware Upgrading	
	Red Light On	Device Initializing and Not Ready	
	Green Light On	Device Ready	
	Green Light Flashing	Data Collecting	
	Green Light Fast Flashing	Stop Collection, Saving Data	
	Blue Light Flashing to End	Power Off	
System Indicator	White Light On	System Firmware Upgrade in Progress	
	Red Light Flashing	System Not Ready	
	Blue Light Always On	System Ready	
RTK Indicator Light	Red Light Fast Flashing	No Internet	
	Red Light Slow Flashing	Internet	No Location
	Red Light On		Single Point Solution
	Blue Light On		Pseudo-distance Solution
	Green Light Slow Flashing		Float Solution
	Green Light On		Fixed Solution

	Status	Prompt Tone
Buzzer	Power on	Beep
	Power Off	Beep
	Low Battery	Beep every 10 seconds
	Ultra-low Battery	Beep every second
	Mark Point Information Collection	Click Information Collection Success
	Start Collection	Beep
	Stop Collection	Beep
	Start Work 1 Minute to Start Mapping	Beep
	Data Storage Complete	Beep

SALM200E Battery LED Indicator Status List					
Status		LED1	LED2	LED3	LED4
Discharge Protection Status	Under voltage	Flash(5Hz)	Slow Flash(1Hz)	Out	Out
	Discharge Low Temperature	Flash(5Hz)	Out	Slow Flash(1Hz)	Out
	Discharge Over Temperature	Flash(5Hz)	Out	Out	Slow Flash(1Hz)
	Discharge Over current	Flash(5Hz)	Slow Flash(1Hz)	Slow Flash(1Hz)	Out
	Discharge Short Circuit	Flash(5Hz)	Slow Flash(1Hz)	Slow Flash(1Hz)	Slow Flash(1Hz)
Charge Protection Status	Over voltage	Slow Flash(1Hz)	Out	Out	Flash(5Hz)
	Charging Low Temperature	Out	Slow Flash(1Hz)	Out	Flash(5Hz)
	Charging Over Temperature	Out	Out	Slow Flash(1Hz)	Flash(5Hz)
	Charging Over current	Slow Flash(1Hz)	Slow Flash(1Hz)	Out	Flash(5Hz)
Power Indicator	0%~12%	Slow Flash(1Hz)	Out	Out	Out
	13%~24%	Always On	Out	Out	Out
	25%~37%	Always On	Slow Flash(1Hz)	Out	Out

	38%~49%	Always On	Always On	Out	Out
	50%~62%	Always On	Always On	Slow Flash(1Hz)	Out
	63%~74%	Always On	Always On	Always On	Out
	75%~87%	Always On	Always On	Always On	Slow Flash(1Hz)
	88%~100%	Always On	Always On	Always On	Always On
Charging Indicator	0%~24%	LED1->LED4 Streaming Lamp Display			
	25%~49%	Always On	LED2->LED4 Streaming Lamp Display		
	50%~74%	Always On	Always On	LED3->LED4 Streaming Lamp Display	
	>=75%	Always On	Always On	Always On	Slow Flash(1Hz)
	Full	Always On	Always On	Always On	Always On
Upgrade Status		Slow Flash(1Hz)	Slow Flash(1Hz)	Slow Flash(1Hz)	Slow Flash(1Hz)

**Description:**

The LED will light up for 6 seconds when you press the key to check the power level, the first 3 seconds will show the power level, the last 3 seconds will show the power level if the battery is normal, otherwise it will show the protection. For more detailed lamp instructions, please refer to the SLAM200E Product Manual.

## Battery Charging

### Battery Charger



Charge the SLAM200E battery handle, about 2 hours to full (0% to 100%)

Input: AC 100 V to 240V to 50/60 Hz

Output: Support PD3.0 Protocol 20V 3A

### Charge Method

Method 1: Connect the charger to the Type-C2 port of the SLAM200E smart battery handle for charging.

Method 2: When the smart battery handle is installed on the SLAM200E body, connect the charger to the Type-C1 port on the body for charging.

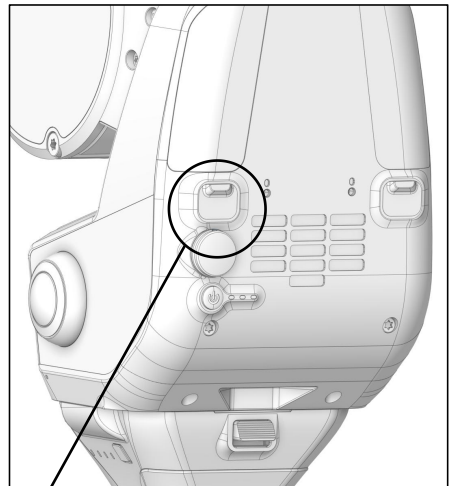

Charge interface

## Power Supply

The SLAM200E is powered by a smart battery handle, providing enhanced safety and reliability. The operating voltage is 10.8V, and each battery can provide continuous operation for approximately 70 minutes (with only the SLAM200E in use). Under normal maintenance and usage conditions, the battery has a charge/discharge cycle life of  $\geq 500$  cycles.

### Notice!

#### 【Charging】

- Do not use non-standard power adapters to charge the battery.
- If the battery temperature is high after use, wait for the smart battery handle to cool down to normal temperature before charging. The battery charging environment temperature should be within the range of +5°C to +40°C.
- Charge in an isolated area, away from flammable materials.
- To avoid electric shock hazards, do not open the charger without proper authorization.

#### 【Usage】

- The battery's operating temperature should be controlled between -10°C and +50°C. If the battery temperature is too low, it may affect battery life and may even prevent the device from operating.
- Avoid direct sunlight exposure on the smart battery handle when used outdoors.
- Ensure that the device connectors are dry and free of water before making connections.
- When using the battery in low-temperature environments (-10°C to +15°C), battery life may be reduced. Preheating the battery to above 15°C before use can help extend battery life.
- Do not remove the battery directly from a powered device.

- Low temperatures will trigger the low-temperature charging protection, which prevents charging.
- Do not continue using a battery that has been deformed due to dropping or impact.
- If the battery accidentally falls into water, immediately remove the battery and place it in a safe, open area. Stay away from the battery until it is fully dried. A dried battery should not be reused and should be disposed of according to the waste disposal instructions.
- In case of a battery fire, immediately use sand, a fire blanket, dry powder, or a CO2 fire extinguisher to put out the fire. Larger fires may lead to explosions. Choose the appropriate fire-fighting method based on the situation.
- Using non-official Feima Robotics batteries is strictly prohibited. If you need to replace the battery, please purchase it from Feima Robotics' official website or authorized channels. Feima Robotics is not responsible for any battery accidents or device failures caused by using non-official batteries.
- The battery storage temperature and humidity requirements are  $-20^{\circ}\text{C}$  to  $+45^{\circ}\text{C}$  and 45% to 90% RH.
- Do not use swollen, leaking, or damaged batteries, or charge them. If the battery emits an odor, overheats (battery temperature exceeds  $60^{\circ}\text{C}$ ), deforms, discolors, or exhibits any other abnormal behavior, it should not be used. In case of abnormal battery conditions, contact Feima Robotics' after-sales service or an authorized distributor for further handling.
- The battery should only be used in environments with temperatures between  $-10^{\circ}\text{C}$  and  $+50^{\circ}\text{C}$ . Temperatures above  $+50^{\circ}\text{C}$  may cause the battery to catch fire or even explode. Temperatures below  $-10^{\circ}\text{C}$  will severely damage the battery.
- Never disassemble or puncture the battery with sharp objects. This could cause the battery to leak and potentially catch fire or explode.
- Avoid mechanical impacts, crushing, or throwing the battery. Do not place heavy objects on the battery or charger.

- If the battery is dropped or subjected to an external impact, stop using it immediately.
- Never heat the battery. Do not place the battery in a microwave or pressure cooker.
- Do not place the battery contacts on conductive surfaces (such as metal desks, glasses, watches, jewelry, etc.).
- Avoid short-circuiting the positive and negative terminals of the battery with wires or other metal objects.
- If the battery connectors are dirty, wipe them with a clean, dry cloth. Otherwise, poor contact may result in energy loss or charging failure.
- **【Transportation】**
- During transportation, the battery should be placed in secure and stable packaging to avoid contact with liquids or impacts with hard objects. Never immerse the battery in water or get it wet. Contact with water inside the battery may trigger a chemical reaction, potentially causing the battery to self-ignite or even explode.
- **【Maintenance】**
- After each operation, recharge the battery promptly. Do not store low-battery batteries for long periods. If the battery will not be used for an extended period, charge it to over 50% and store it. Perform a charge-discharge cycle every three months for maintenance.
- **【Battery Storage】**
- Store the battery in a place out of reach of children and pets.
- The battery should be stored in an explosion-proof box in a cool, dry place. Avoid long-term exposure to high temperatures and direct sunlight.
- Do not store the battery near heat sources (such as stoves or heaters) or inside a hot car. Never store the battery in an environment exceeding +45°C. The ideal storage temperature is between 22°C and 28°C.
- Do not store the battery in environments with alternating high and low

temperatures.

- Do not store the battery fully charged in a transport box when the temperature exceeds +45°C.
- Storing the battery at low charge for a long time may lead to over-discharge, which could render the battery unusable.
- Avoid placing sharp objects with the battery or puncturing it.
- Prevent the battery from falling or getting damaged.
- Store the battery in a dry environment.
- Never store the battery after it is completely discharged for a long time, as it may enter an over-discharge state, causing irreversible damage..
- **【Battery Disposal】**
- Do not disassemble, strike, crush, or throw the battery into a fire. Never place the battery in a high-temperature environment.
- If the battery is swollen, has damaged outer skin, or is leaking, do not use it again. Dispose of it promptly.
- Always discharge the battery completely before disposing of it in a designated battery recycling bin. Batteries are hazardous materials, and it is strictly prohibited to dispose of them in regular trash bins. Follow local laws and regulations for battery recycling and disposal.
- If the battery cannot be fully discharged, do not dispose of it directly in a recycling bin. Contact a professional battery recycling company for further handling.

## Data Storage

- The SLAM200E uses an internal SSD with a capacity of 512GB, and data can be transferred via a data cable connected to a PC.
- The SLAM200E SSD interface (Type-C2) supports data reading in both powered-on and powered-off states.
- It is recommended to keep at least 5% of the SSD disk space free to avoid slow read/write speeds and insufficient capacity due to excessive data.
- When deleting data, it is recommended to use formatting (quick format is acceptable) to optimize the SSD disk's storage speed.

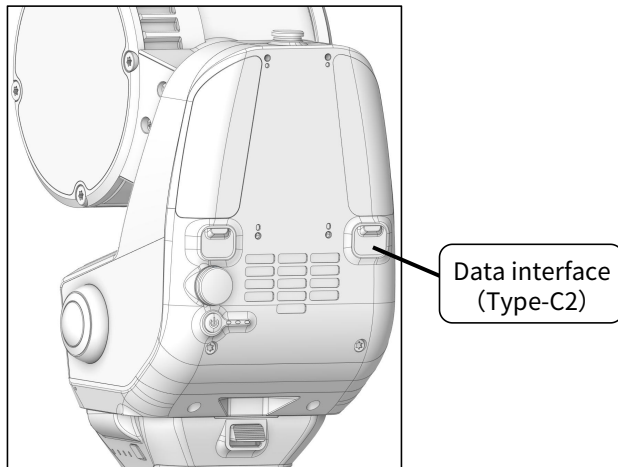

## Device Activation

The scanner must be registered with a Feima account and activated before use. For specific software download addresses and the registration and activation process, please refer to the "SLAM GO" section.

## Data Collection

### Device Power-On

Press and hold the scan button for 3 seconds to power on the device. After powering on, the device will perform a self-test. Please wait...

- The system indicator light will show a steady blue light.
- The status indicator light will show a steady green light.
- Laser head stops rotating.

At this point, the device has successfully started and is in standby mode.

### Notice!

- When powering on the device, hold the scanner steadily and keep the laser head upright.
- Do not manually rotate the laser after the device self-check is complete.
- Place the scanner on a safe, stable table or a flat surface if needed.

---

## Start Data Collection

Before starting data collection, the scanner needs to perform a calibration. The placement requirements are: the distance from the object being measured should be greater than 0.4 meters, but not too far. The calibration phase must last at least 60 seconds before motion-based data collection begins. During calibration, do not hold the scanner in your hand; it must be placed steadily on a safe surface like the floor or a table.

Press the scan button briefly, and the status indicator light will start flashing green rapidly. At this time, the device is performing calibration, which takes 60 seconds (the mobile app will show a countdown). After 60 seconds, the status indicator light will switch to flashing green slowly, and data collection will begin. If the scanner is placed at a slight angle but remains stationary, it still meets the calibration requirement.

### Tips:

- During data collection, keep the scanner in front of your body and aligned with your walking direction. Please keep the device upright.
- After powering on and during data collection, the device may heat up, and the sound of the cooling fan may be heard. This is a normal phenomenon.

## Control Point Collection

When collecting control points(GCPs), first align the cross center on the device base with the control point. Then, briefly press the control point collection button. After hearing a “beep” sound, the control point will be successfully collected. There is no need to wait during control point collection; once the current GCP information is collected, you can continue with the subsequent data collection.

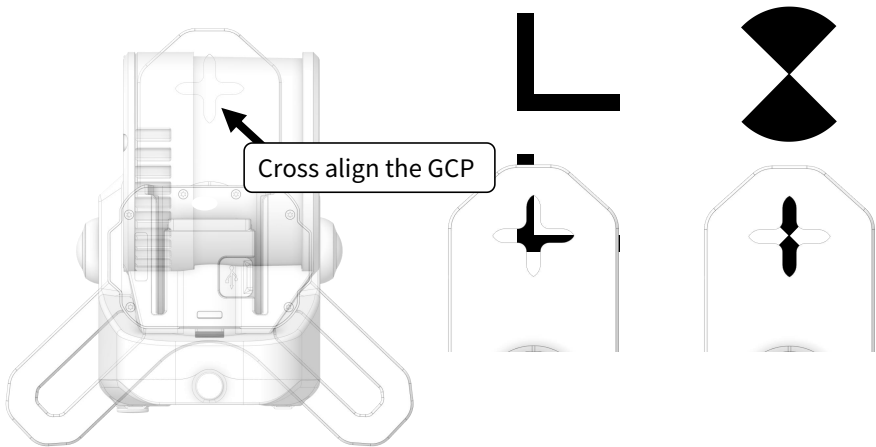

Top view

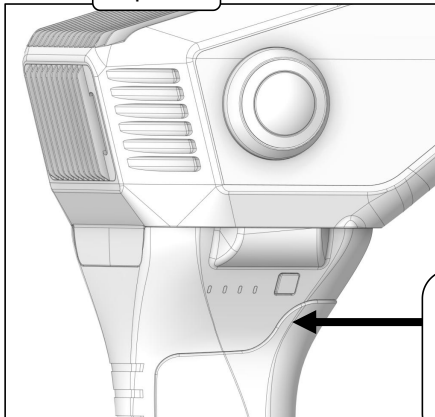

When you need to collect a control point, briefly press this button. After hearing a "beep" sound, the control point will be successfully collected

---

## Stop Data Collection

Press the scanner power button briefly to end data collection; the status indicator will return to the standby state with a steady green light.

If you need to obtain the device “real-time mapping” results, wait for the device to complete the “real-time mapping” process before powering off or starting the next collection. The wait time is approximately 1/10 of the collection duration.

For example, if the collection time was 10 minutes, wait for 1 minute after stopping the collection.

## Power Off the Device

Press and hold the scan button to power off the device. Wait until both the system indicator and status indicator lights are completely off, at which point the device will be powered off.

### **Notice!**

- Please do not remove the smart battery handle before both the system and status indicator lights are completely off.

## Data Check

After data collection is completed, you can turn off the scanner and connect the SLAM200E to a PC using a data cable. Locate the folder named “SN\_XXXXX” and copy it to a backup directory. After each data collection session, the system will automatically generate this folder. The numerical suffix at the end of the folder name helps identify the order in which the data was collected.

## Problem Analysis

If there are issues with the collected data, please compress the folder named “LOG” in the scanner’s storage card and submit it to the Feima after-sales department for analysis.

## SLAM GO Operating Instructions

### Overview

### Description

SLAM GO APP is a high-end supporting application specially built for SLAM200E, realizing an efficient solution for lightweight mobile real-time viewing and processing of scan data. The app can connect to SLAM200E wirelessly, display 2D and 3D scan data in real time, and support real-time viewing of modeling models and its positioning. SLAM GO diverse functions will greatly improve user efficiency and convenience in real-world application scenarios, making it the preferred application for many professionals.

### Device Environmental Requirements

Android 9.0 and above operating system.

iPhone iOS12.0/iPad iPadOS12.0 or later version.

## Installation Method

Download for Android: <http://ios.feimarobotics.com/3vu9>



 SLAM GO

IOS version download: Search for SLAM GO in the App Store to get it.

Google play store & Apple store.

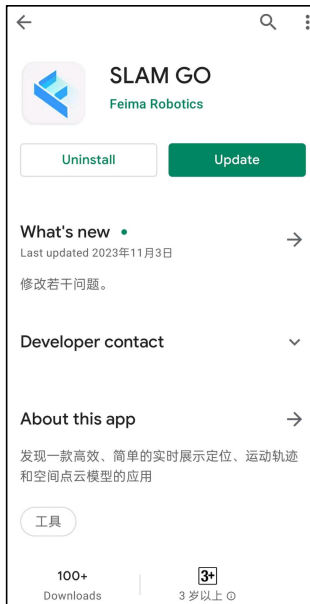

**Notice:** (The interface style of the SLAM GO APP may vary with different versions of SLAM GO. The illustrations provided below might not match the actual interface of the SLAM GO you are currently using. Please refer to the latest version of the SLAM GO interface for accuracy.)

---

## SLAM GO Registration and Login

### Register Feima account

#### Register by Phone Number

Click User on the home page of the APP, click Register New User to enter the registration page, select the correct international area code (for example China's international area code is +86), fill in the correct cell phone number, and get the verification code. Enter the password, the password length should be no less than 6 digits. Check the 'I have read and agree to the user agreement, privacy policy' option at the bottom of the page, click Register. After registration, you can log in. This account can log in to all products of Feima once required.

#### Register by E-mail

Click User on the home page of the APP, click Register New User, click Email Registration, you can enter the email registration page, fill in the correct email address (example: xxx@ outlook.com), and get the verification code. Enter the password and confirm the password, the password length should be no less than 6 digits. Check the option of I have read and agree to the user agreement and privacy policy at the bottom of the page, click Register. After registration, you can log in. This account can log in to all products of Feima once required.

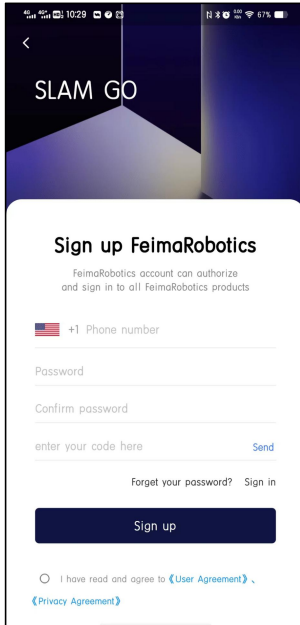

**Sign up FeimaRobotics**

FeimaRobotics account can authorize and sign in to all FeimaRobotics products

+1 Phone number

Password

Confirm password

enter your code here [Send](#)

[Forget your password?](#) [Sign in](#)

[Sign up](#)

I have read and agree to [《User Agreement》](#) , [《Privacy Agreement》](#)

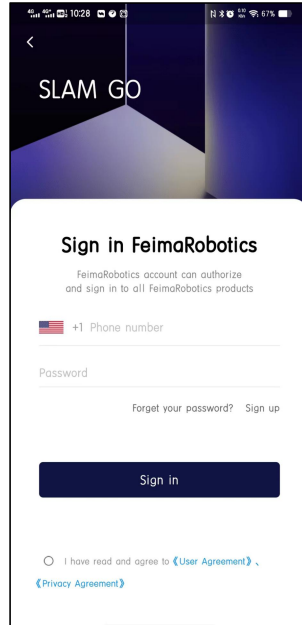

**Sign in FeimaRobotics**

FeimaRobotics account can authorize and sign in to all FeimaRobotics products

+1 Phone number

Password

[Forget your password?](#) [Sign up](#)

[Sign in](#)

I have read and agree to [《User Agreement》](#) , [《Privacy Agreement》](#)

Phone/Email register

## Login Account

### Phone Number Login

Open the SLAM GO APP, click User, select the correct international area code (e.g., China's international area code is +86), fill in your Feima cell phone account and password, check the I have read and agree to the user agreement, privacy policy option at the bottom of the page, and click Login.

### E-mail Login

Open the SLAM GO APP, click User, click Email Login on the pop-up login page, fill in your Feima email account and password, check the I have read and agree to the user agreement, privacy policy box at the bottom of the page, and click click Login.

Other Login Entries: ①Click S-RTK on the main interface to log in. ② Click Project - My Project under Login to log in.

If you forget your password, you can reset it by going to the User interface and clicking the Security Center option, or go to Forgot your password. on the login page and follow the instructions to retrieve your password.

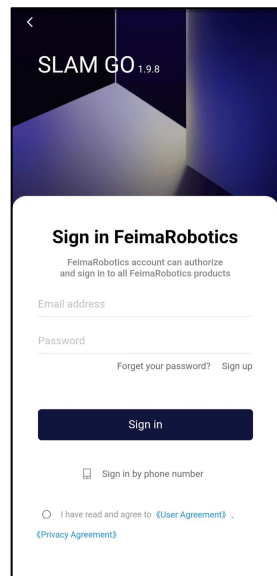
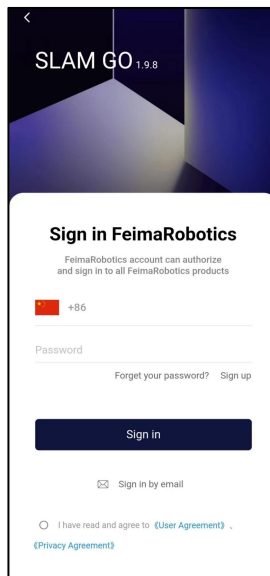
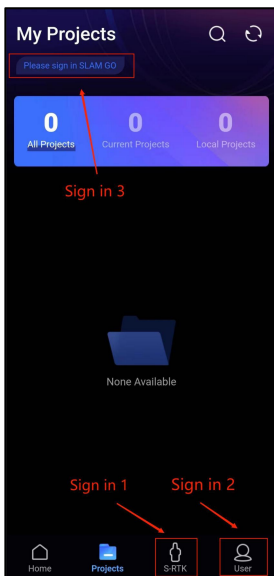

## Personal Center

Personal Center - User includes user name and avatar display, modify user name, security center, activation request view, language setting, permissions and privacy settings, about SLAM GO, and sign out.

When you install SLAM GO for the first time, you need to click Personal Center - User to log in before you can use all the functions of the app.

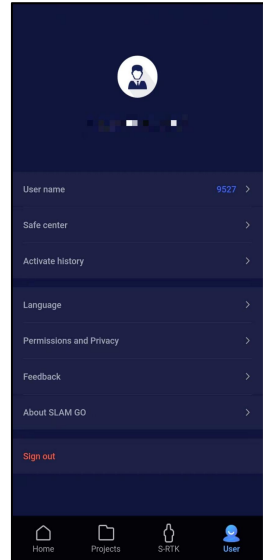

## Change Login Password

Click on Safe Center – Change Password in the personal center, enter the old password, new password, and confirm the new password in the input box. Click Confirm to make the modification successful. The system will automatically log out of the current account. Please restart the software to log in.

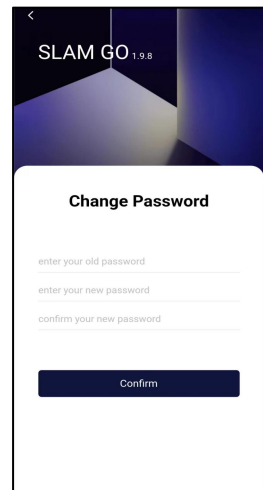

## Activation Request

Click on the Activation Application button in the personal center to view the activation history of all SLAM200E scanners under the current account.

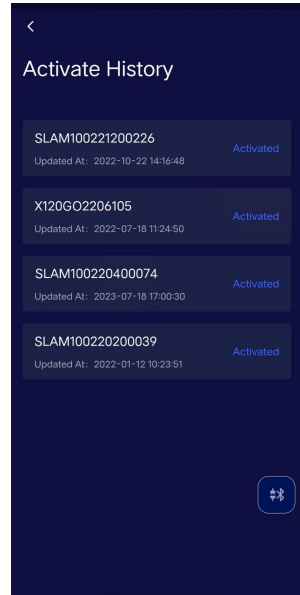

## Language Setting

SLAM GO supports multiple languages, including Chinese, English, Italian, German, French, Japanese, Korean, Arabic and so on.

Click on the User - Language setting, and in the Language pop-up window, you can select the language you want to switch (when SLAM GO is first started, the default language of the app is the current language of the system).

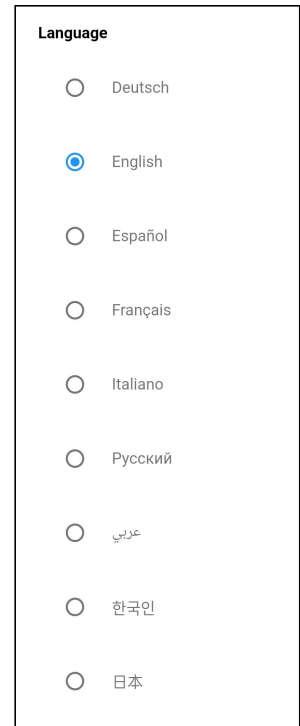

## About SLAM GO

You can view the latest and current versions of the app, the copyright ownership of the app, and download and upgrade to the latest version.

## Software Upgrade

When you enter SLAM GO home page or User - About SLAM GO, the app will automatically detect the version upgrade (need to connect to the Internet). If there is the latest version, the Upgrade Now button will be displayed at the bottom of the app home page or the About SLAM GO page. Click Upgrade now, SLAM GO will automatically download the latest installation package. Then click Install, the app will be upgraded to the latest version.

## Exit Login

Click Sign out to log out of the currently logged in account and return to the login page.

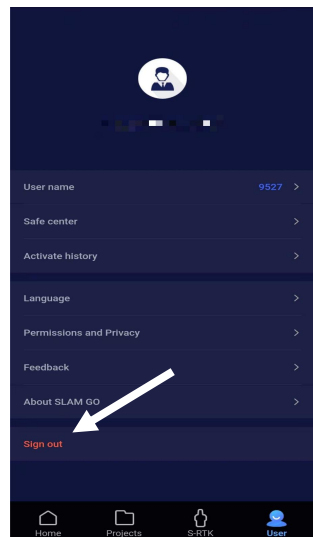
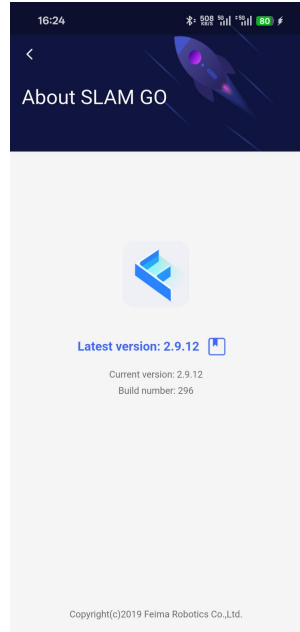

## APP Home Page

The home page includes connecting the SLAM200E scanner, activation history, searching for devices, scanning codes to connect devices, device types, currently connected devices, and historically connected devices.

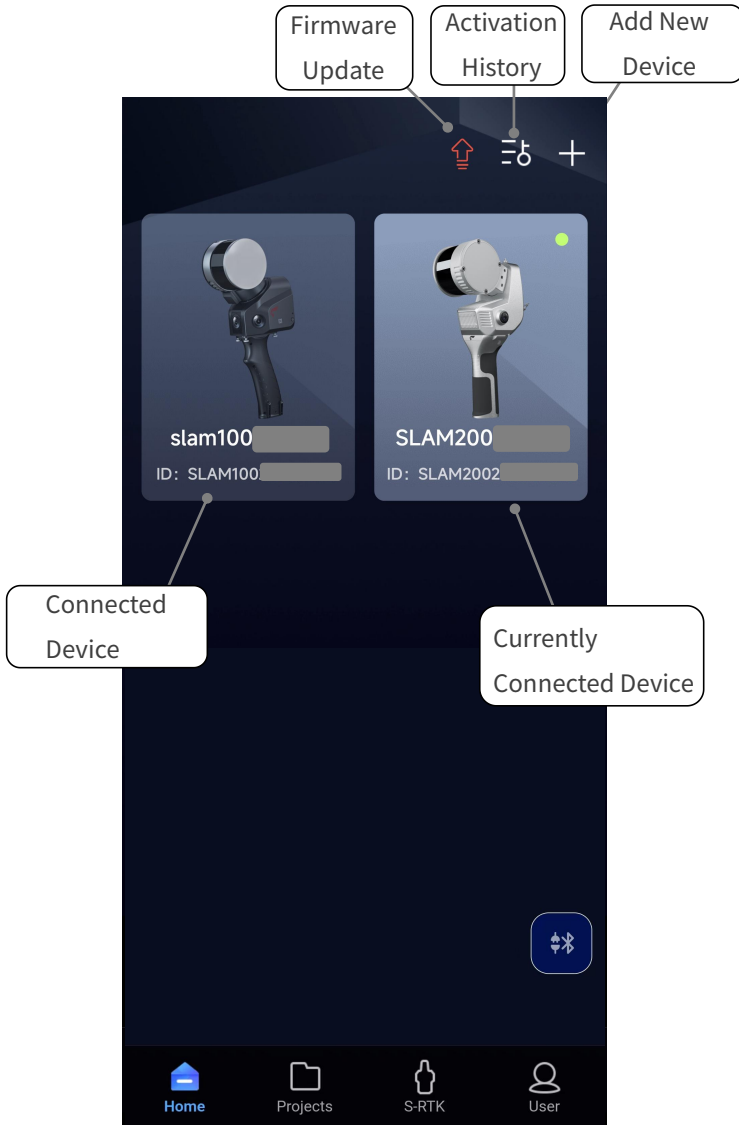

## Device Binding

The SLAM200E connects and interacts with your phone through its "Hot spot." The specific steps are as follows:

1. Turn off your phone's Wi-Fi, then enable "Bluetooth" and "Hot spot."

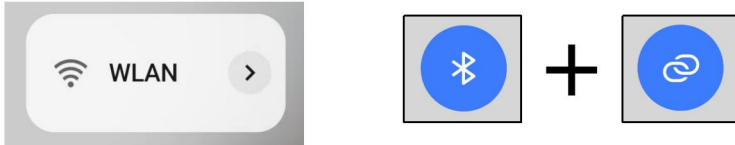

2. Power on the SLAM200E. Open the SLAM GO APP home screen and tap "Bind Now" or "+" to add a new device.

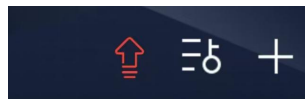
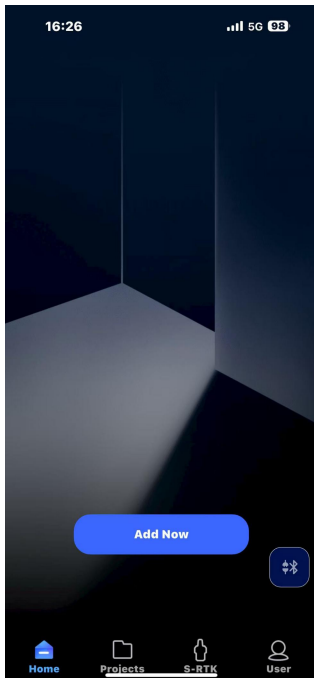

3. 2.Swipe the interface to the left to the "Bluetooth" interaction section. The app will automatically detect the new device. Select and tap the device you want to bind.

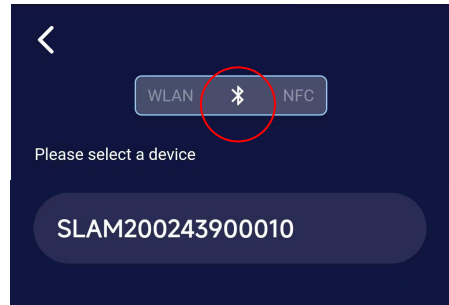
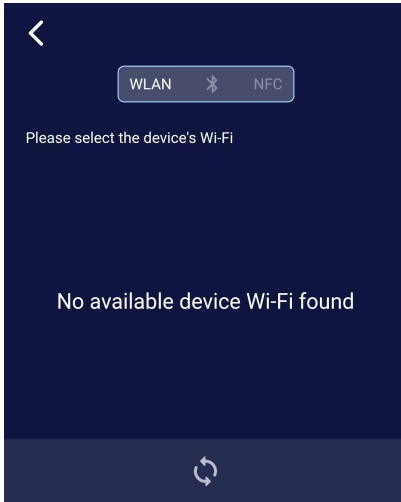

4. After selecting the phone's "Hot spot" network and entering the correct "Hot spot" password, you will see that the device is connected.

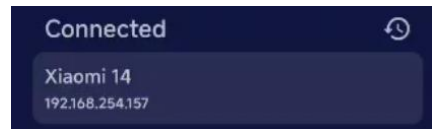

5. After the device is successfully bound, the newly added device will be visible on the SLAM GO home screen.

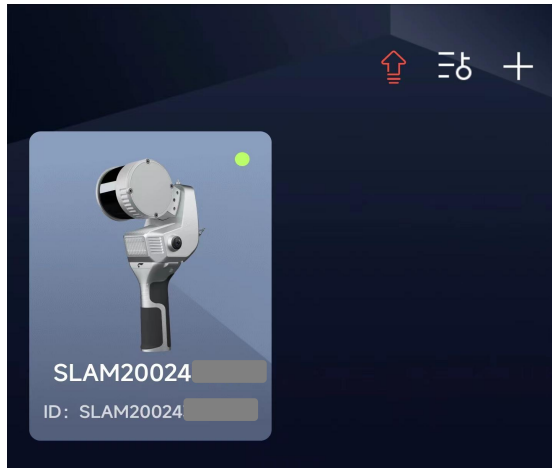

## Device Activation

The SLAM200E scanner must be activated through the SLAM GO APP. The activation process requires approval from Feima's customer service cloud before the device can be used.

Unactivated SLAM200E scanners will automatically appear on the SLAM GO home screen.

Tap the scanner icon with a green dot in the top-right corner to open the activation information form. Fill in the required information and follow the steps below to successfully activate the device.

Before activating the SLAM200E scanner, please contact Feima's after-sales service in advance for online assistance with activation.

### Activation Process

1. Use your phone's "Hot spot" to connect to the unactivated SLAM200E scanner. Once connected successfully, an online device with a green dot in the top-right corner will automatically appear on the home screen. (If the device does not appear, completely close the app and reopen it.) Tap the SLAM200E scanner device with the green dot.

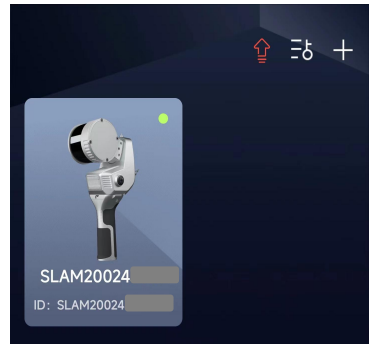

2. When activating the device, ensure that the phone connected to the scanner has internet access with a stable signal. After tapping the device, the "Activate Device" page will pop up. Follow the prompts to fill in the contact name, phone number, and organization, then click the "Complete" button. The activation request will automatically be sent to Feima's customer service. Further operations can only proceed after the customer service team approves the activation.

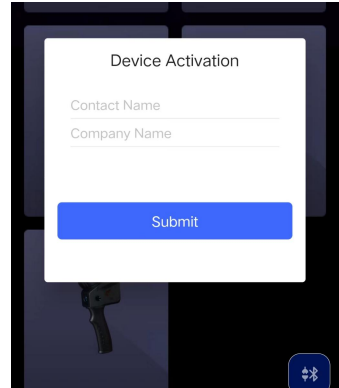

3. After the activation request is approved, ensure that your phone remains connected to the internet. Wait for approximately one minute for the activation information to automatically upload from the app to the server. If the message "Please connect to Wi-Fi" appears, it indicates that the SLAM200E scanner has been approved.
4. Once Feima customer service approves the activation, reopen the SLAM GO APP. When the message "Device activation approved" appears, tap "Confirm." Reconnect the SLAM200E scanner via "Hot spot" to complete the synchronization and activation process with the SLAM GO APP.

## Activation Application Under Review

After completing the activation information, re-enter the APP later and connect to the SLAM200E scanner via "Hot spot." Tap the device with a green dot in the top-right corner, and a message saying "Activation application under review" will appear. Please wait for Feima customer service approval. If the message persists for an extended period, contact Feima after-sales support for further assistance.

## Activation Application Rejected

If your activation application for the SLAM200E scanner is rejected, promptly contact Feima's official customer service and follow their guidance to reactivate the device.

## Activation History

Tap "Activation History" in the top-right corner of the home screen to view the activation history and status of SLAM series devices.

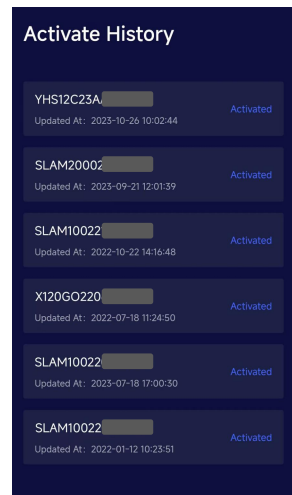

## Device Connection Status

### Device Status - Connected Successfully

Connect the SLAM200E scanner via your phone's "Hot spot." Tap the online device with the green dot icon in the top-right corner of the APP page to enter the device operation page. A "Connected Successfully" message will appear, and the device will begin initialization.

### Device Status - Initializing

After successfully connecting to the device, it will proceed with initialization. Once initialization is complete, the device will enter standby mode.

### Device Status - Standby

After initialization, the device will enter standby mode, indicating it is not yet in operation.

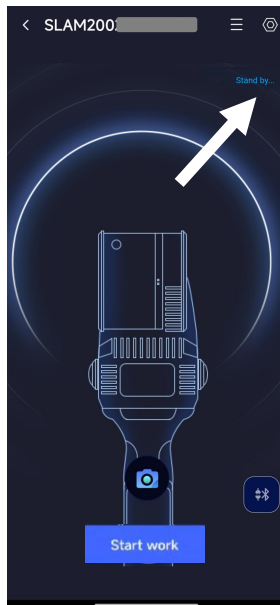

---

## Device Status - Connection Failed

If the device connection fails, please check the device connection status and troubleshoot step by step:

- ① Ensure that the SLAM200E is still connected to the phone's "Hot spot."
- ② Check if the SLAM200E status indicator light is solid green.
- ③ Exit the operation interface and return to the home screen. Check if the connected device icon in the top-right corner has a green dot.
- ④ Try completely closing the SLAM GO APP, clearing the app's background, then reopen the SLAM GO and attempt to reconnect to the SLAM200E device.

If after performing the above steps, you still encounter a connection failure when re-entering the device operation interface, please contact Feima after-sales support for further assistance.

## Device Status - Out of Communication Range

When the SLAM GO APP disconnects from the SLAM200E, the device status will show "Out of Communication Range." This may indicate that the SLAM200E is no longer connected to the phone's "Hot spot," or the distance between the phone and device is too far, causing weak or lost "Hot spot" signal.

## Standby Test Capture

When the device is in standby mode, ensure that the front camera of the SLAM200E is unobstructed. Tap the capture button at the bottom of the standby screen to perform a test capture and check the camera status. You can view the preview image taken by the camera in the preview interface.

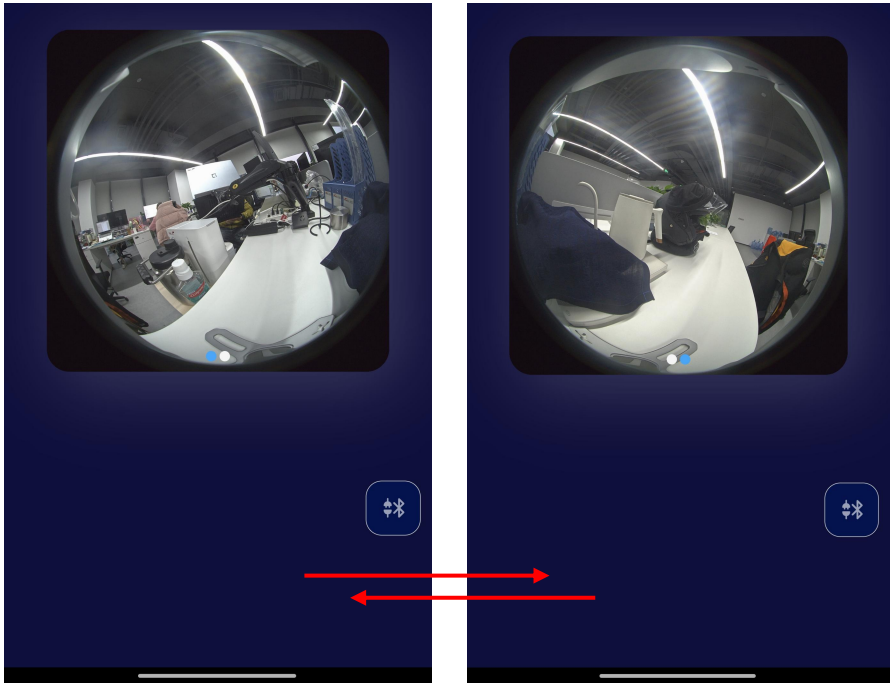

## Device Operation

After connecting the SLAM200E via the SLAM GO APP, the app will enter the standby page. Press the power button on the SLAM200E briefly, and the system will automatically enter the operation page, beginning to display real-time laser scan data. The device operation interface includes features such as the device name, device information, settings, working duration, operating status, real-time display image, pitch angle control button, and the option to switch between 2D or 3D display.

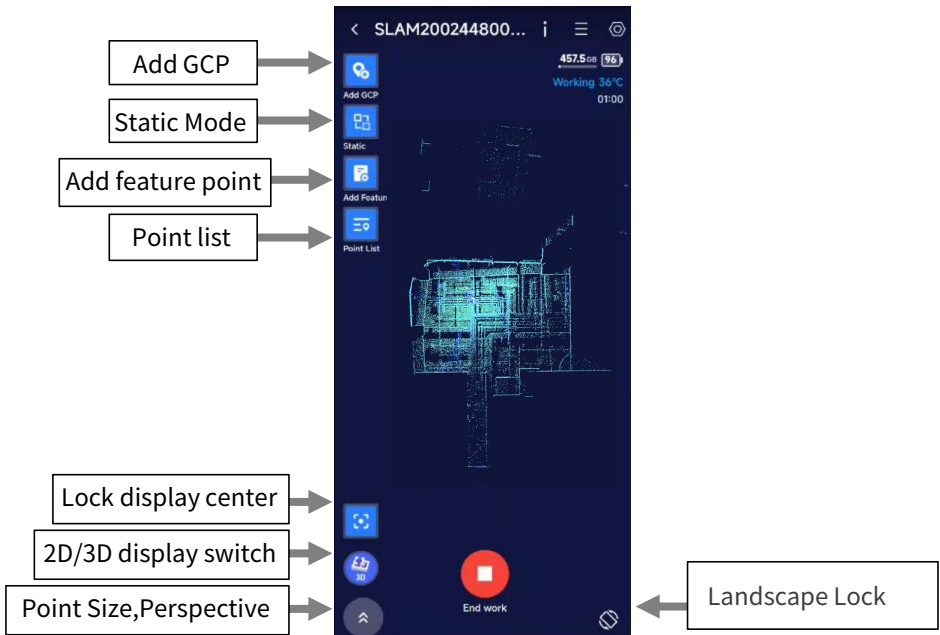

## In Operation - Real-time 3D Scan Display

When the app is on the standby screen, briefly press the power button on the SLAM200E device to start the operation. The page will automatically switch to the 3D scan display interface.

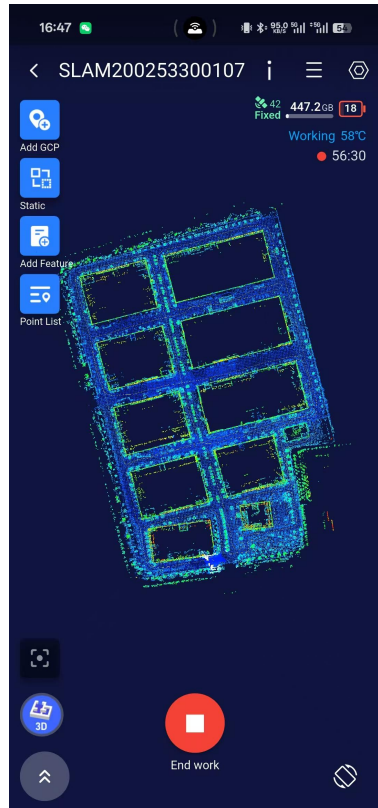
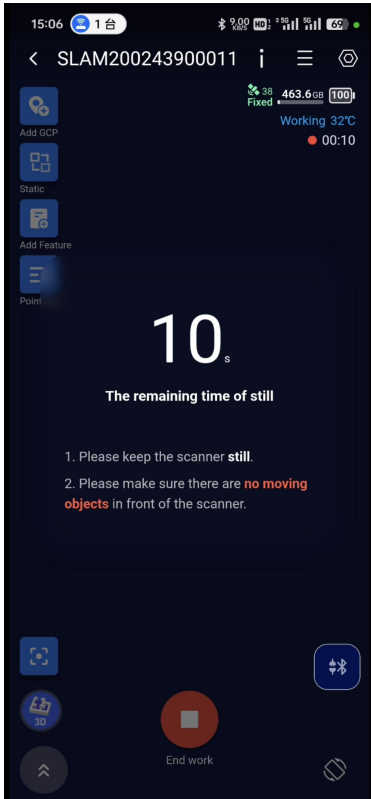

## In Operation - View SLAM200E Status Information

During operation, tap the "Device Information" button in the top-right corner of the work interface to view real-time status information of the SLAM200E, including basic device status, motor status, error status, and disk information.

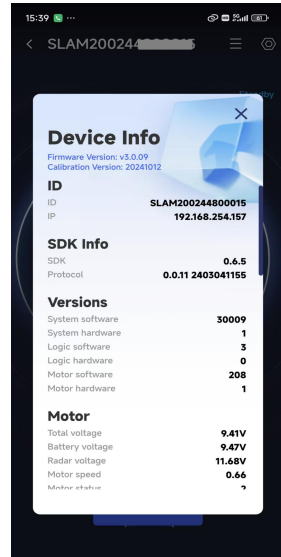

## Control Point Collection Function

During operation, the user can click "Add Control Point" to record the current time of collection into the control point collection file.

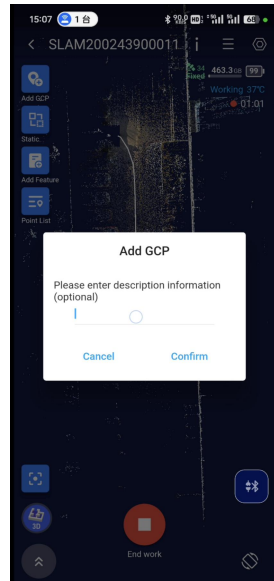

## Settings

Tap the "Settings" button in the top-right corner of the work interface to enter the settings page, where you can adjust device name, RTK settings, camera parameters, and perform firmware upgrades.

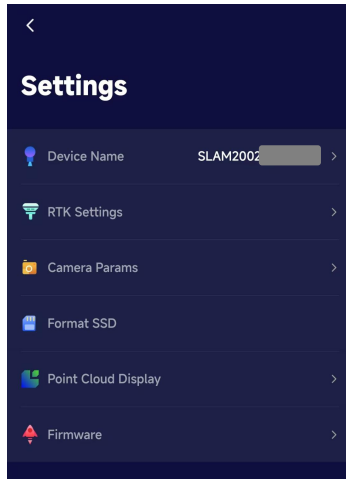

### Modify Device Name

Tap on the device name, and in the pop-up "Modify Device Name" dialog, enter the new name and click "Confirm" to change the device name.

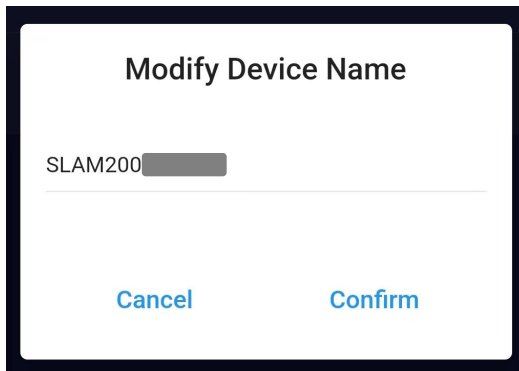

## RTK Settings

The SLAM200E device comes with an integrated RTK module. To enable this feature, the relevant parameters must be correctly set in this interface.

(Note: CORS account may need to be purchased separately; please consult your dealer for details.)

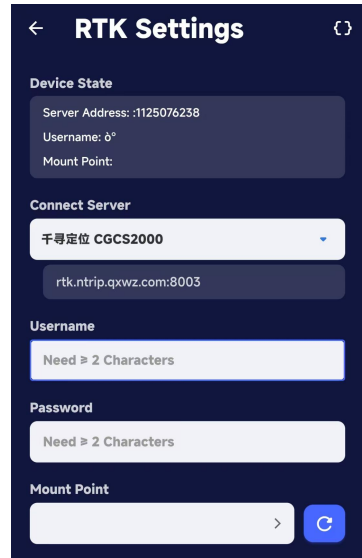

**RTK Settings**

**Device State**

Server Address: :1125076238

Username: 6\*

Mount Point:

**Connect Server**

千寻定位 CGCS2000

rtk.ntrip.qxwz.com:8003

**Username**

Need ≥ 2 Characters

**Password**

Need ≥ 2 Characters

**Mount Point**

> C

## Camera Parameter Settings

- **【Color Camera】**

If point cloud coloring results are not required, you can turn off the "Color Camera" to significantly save storage space on the SLAM200E.

- **【Anti-Flicker】**

When using the camera under LED or other flickering light sources, exposure issues (such as fluctuating brightness) may occur. This is due to the camera's sampling frequency being similar to or the same as the flicker frequency of the light source. You can adjust the "Anti-Flicker" setting to offset the light source's flicker frequency and resolve this issue.

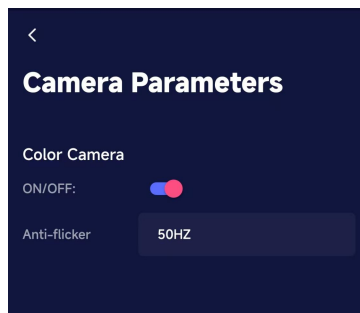

**Camera Parameters**

Color Camera

ON/OFF:

Anti-flicker 50HZ

## Point Cloud Display

When the global preview is turned off, the mobile app will only display a partial point cloud. When enabled, it will show the point cloud collected throughout the entire process.

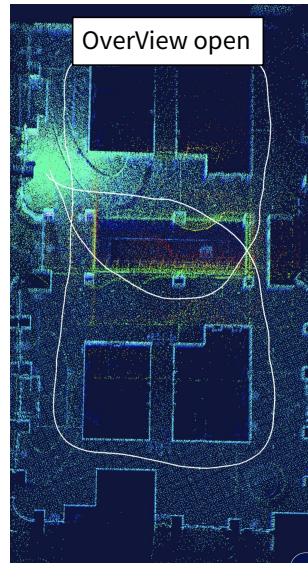
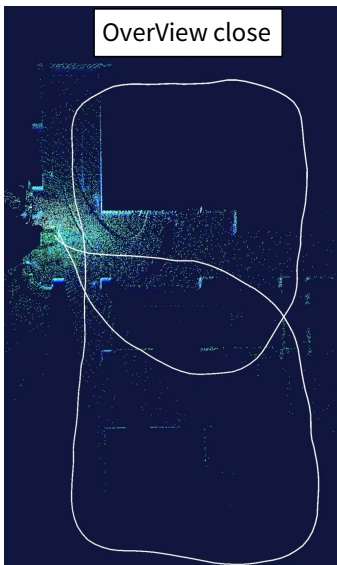
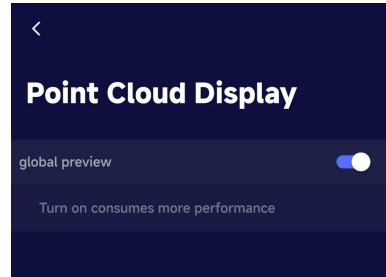

Format SSD

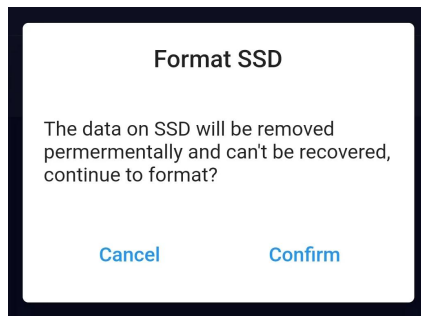

## Firmware Update

A firmware update will optimize the performance of the firmware or device drivers, as well as optimize the performance of the processor or other device hardware. And firmware upgrades can also fix problems found with older versions.

### ➤ Automatic Firmware Upgrade Reminder

Each time you open the app and log in, the app will automatically detect the latest firmware version and the current local firmware version. If the latest firmware file is not downloaded locally, a pop-up window will be displayed on the home page to remind you to download the latest firmware so that you can directly update the firmware after connecting the device.

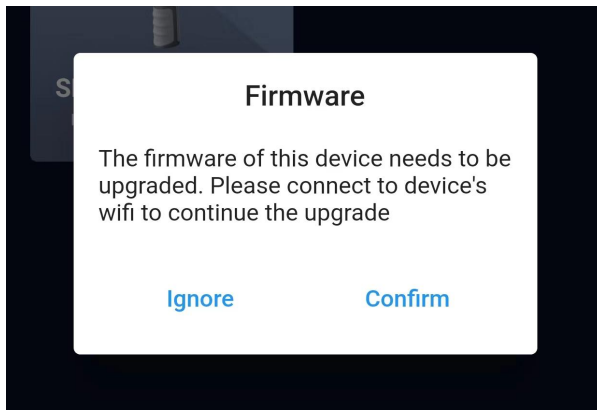

### ➤ Latest Firmware Download

After the firmware upgrade in the pop-up window on the home page, click Update to jump to the firmware download window, click Update to start downloading, do not operate the phone at this time, wait for the download to complete, click Confirm to exit the firmware upgrade window after the download is complete



## ➤ Transfers Firmware to SLAM200E

1. If the SLAM200E is turned on at this time, please turn off the device. Then open the SLAM GO APP first and then turn on SLAM200E, and proceed to the firmware upgrade procedure under the pop-up window prompts on the SLAM GO homepage.
2. After the transmission is completed, click Confirm. At this time, please wait for 35 seconds and then manually restart the device, after restarting the device, pay attention to observe the device indicator light from the upgrade state to normal standby, this time the firmware update is successful, you can use the device normally.
3. You can check the setup page after the upgrade is successful.

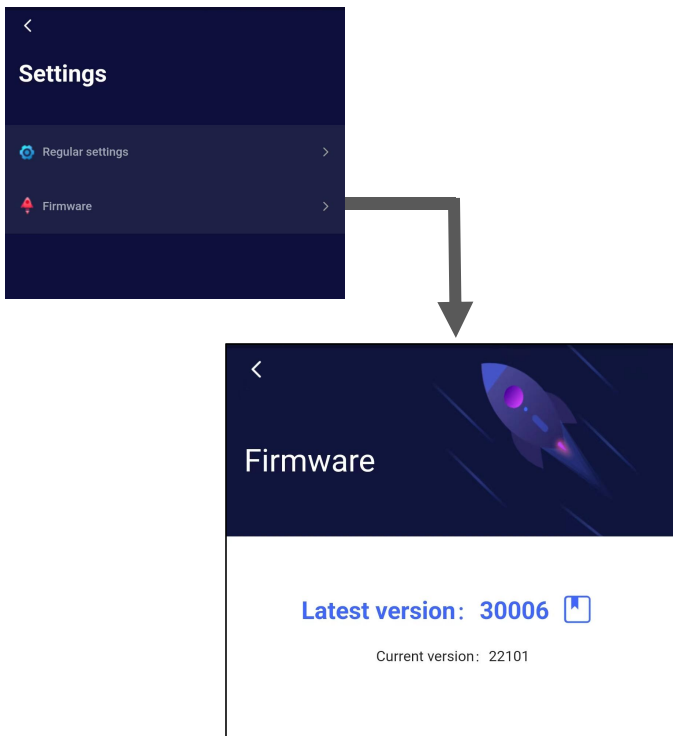

## Delete Device

- When SLAMGO and SLAM200E are connected, enter the working page of the APP, click "Settings" to see the option of "Delete Device", through which you can delete the devices that don't need to appear on the home page.
- Long press a SLAM200E device icon on the home page of the APP, you can check one or more devices that need to be deleted, and click the "Delete" button at the bottom right corner, and then click "Confirm" in the pop-up window, you can remove the checked devices on the home page.

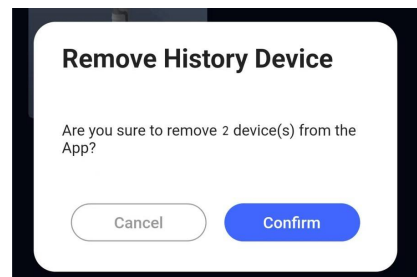
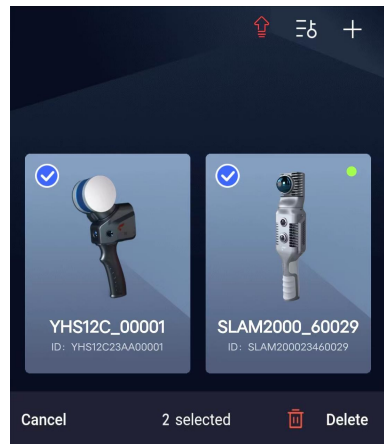
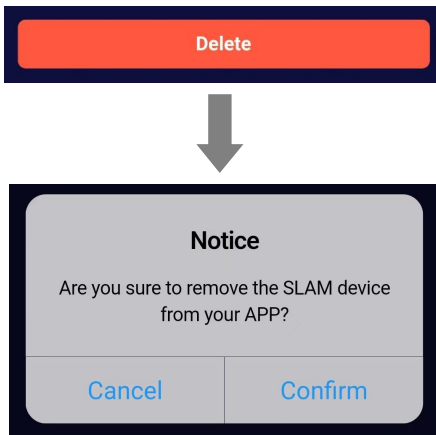

## Project Management

### Project List

【My Projects】page is divided into three project lists:

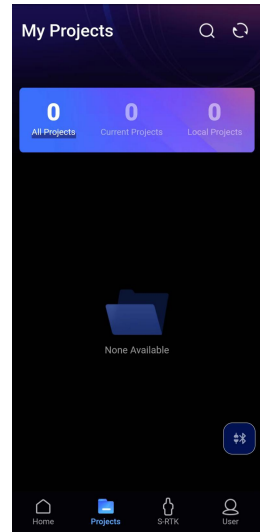

1. Current Device

The projects of the current device are all the projects in the memory of the SLAM200E device that the APP is connecting to.

2. Local Projects

The projects in the Local Projects list refer to the projects to be uploaded to the cloud, which are the projects that are acquired from the SLAM200E device to the local area of the cell phone but have not been uploaded to the cloud yet.

3. All projects

All projects include the current device projects, cloud projects, and local projects that have not been uploaded ( projects that have been synchronized to APP from other SLAM200E devices but have not yet been uploaded to the cloud ).

※ ※ **The app requires you to log in to your SLAM GO account to get the project list in the cloud platform and manage the projects.**

## Project Synchronization

### 1. Get Cloud Project List

After logging in to your SLAM GO account, click the "Synchronize" button in the upper right corner to get the list of all cloud projects

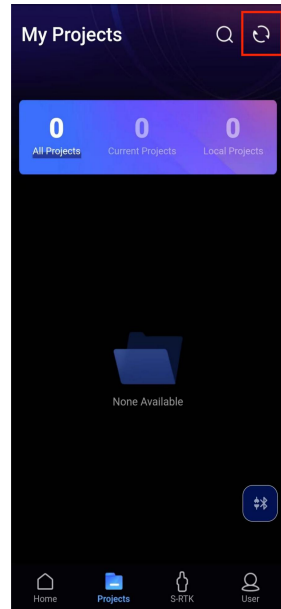

### 2. Get the current SLAM200E device project

Open the SLAM GO APP, connect the SLAM200E device to WiFi, click "Home" to confirm that SLAM200E device has been successfully connected and the status is normal, click "Project" → click the upper right corner of the "Synchronization" button. Click the "Synchronize" button, then it will start to get the project of the SALM200E device and synchronize it to the local project of the APP, please wait patiently!.

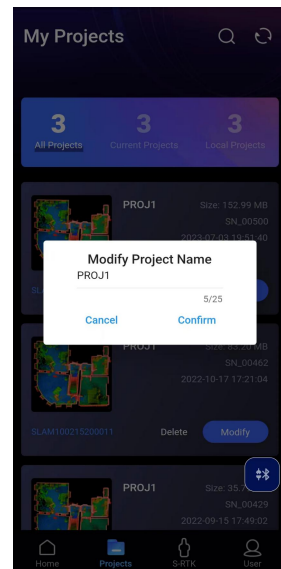

### 3. Synchronize SLAM200E device projects to the cloud

If you want to upload the project of the SLAM200E device to the cloud archive, you need to keep the APP connected to the Internet, click the "Synchronize" button in the upper right corner, and wait for the project to be uploaded to the cloud.

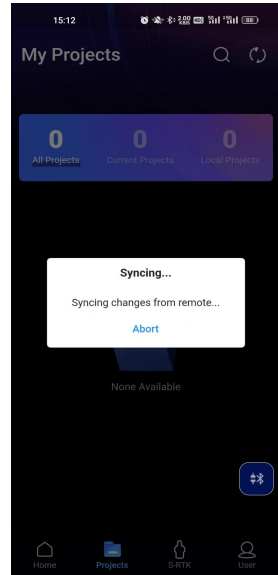

### Project Search

Click the "Search" button in the upper right corner, enter the trip number, project name, or project ID in the input box and click the "Confirm" button to complete the search.

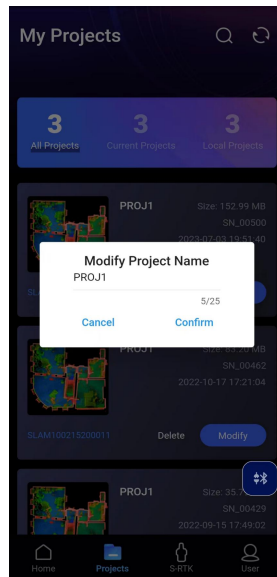
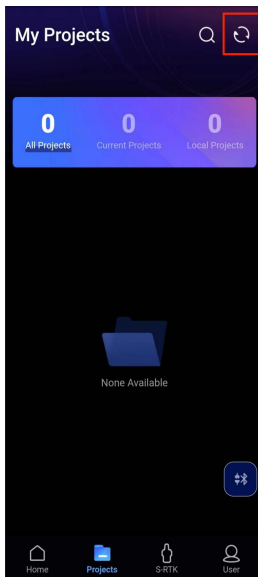

## Modify the Project Name

Click the Modify button in the item column that needs to be modified, enter the name to be modified, click the 'Confirm' button, and then click the button in the upper right corner to upload the modified item to the cloud to complete.

If you modify the project name when connecting to the SLAM200E device, the project name in the SD card of the device will be modified synchronously.

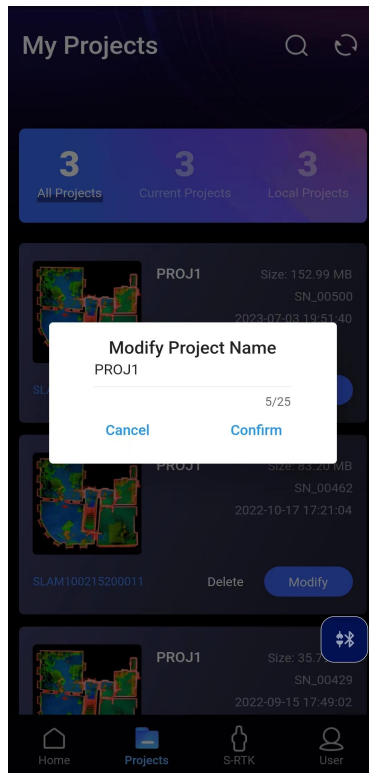

## Project Deletion

Click the Delete button in the item column that needs to be deleted, click to confirm, and then click the button in the upper right corner to upload the deleted items to the cloud to complete.

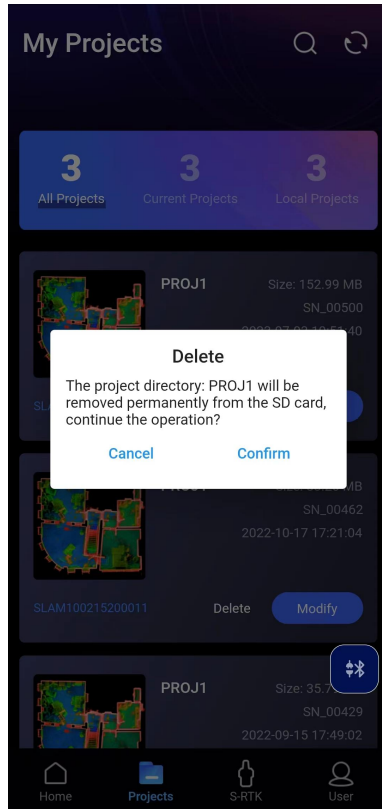

## Diagnosis and Feedback

### Feedback

The feedback function allows you to give feedback on problems, suggestions and comments you encountered while using the app.

Click User in the app, find the 'Feedback' button, click it to enter the feedback page. You can submit your questions and suggestions here and then click Confirm.

We welcome all feedback and suggestions and will review and respond as soon as possible.

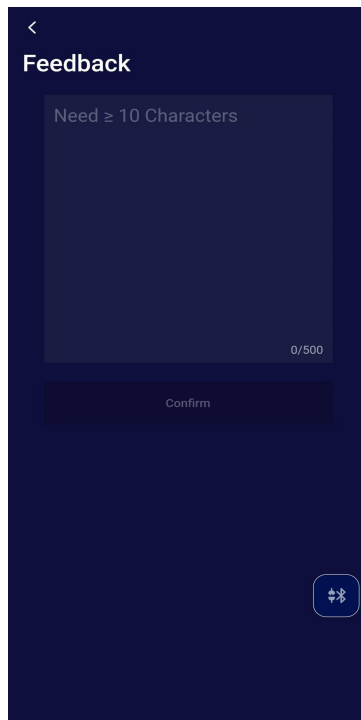

The screenshot shows a dark blue mobile app interface for a feedback form. At the top left is a back arrow icon. Below it is the title "Feedback". A text input field is present with a placeholder text "Need ≥ 10 Characters" and a character count "0/500" at the bottom right. Below the input field is a "Confirm" button. In the bottom right corner of the screen, there is a circular icon with a plus sign and a gear, likely representing a settings or help menu.

## Log File Upload/Export Log

When you encounter problems with the app, you can use the log upload function. The log upload function can help us collect the problem log information of the app so that we can check the defects and problems of the app as soon as possible.

Keep the app connected to the internet, click User in the app, find the Safe center button, click the Upload Log button and confirm in the pop-up window, wait for the upload to finish, then the log upload will be complete.

The Export Log feature allows you to save application logs in your local storage so that you can send them to the Feima support team to help us better understand application issues. To use this feature, you just need to click the Export log button, then the app will export the log information and save it in your phone's local storage, the export path is:

/storage/emulated/0/Download/SLAMGO/Log/xxxxxx.zip.

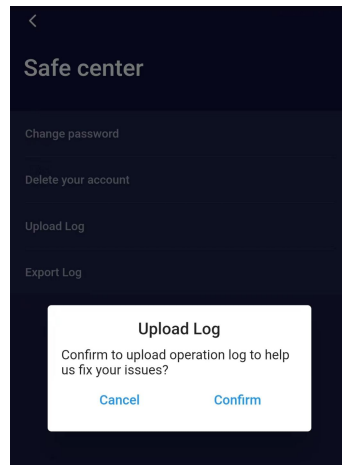
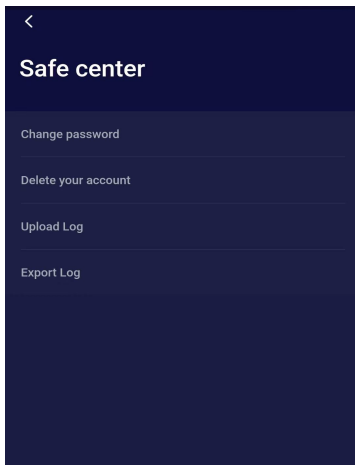

## Data Collection Guidance

### Site Inspection

### Indoor Environment

In case of indoor environment, multi-path locations should be selected as much as possible as the starting and ending points for data collection. After the site inspection, the closed route planning for the measurement area is carried out.

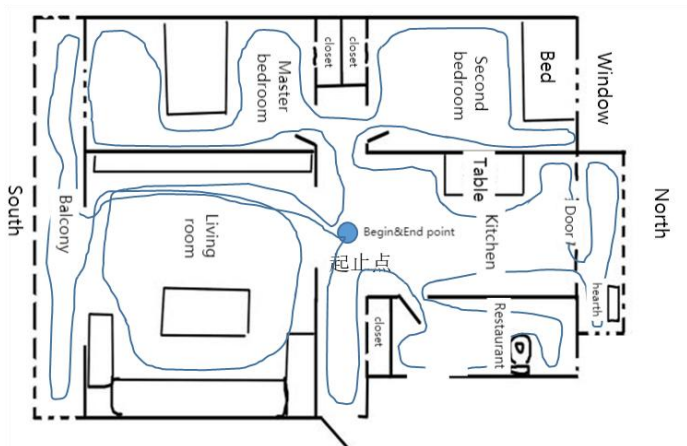
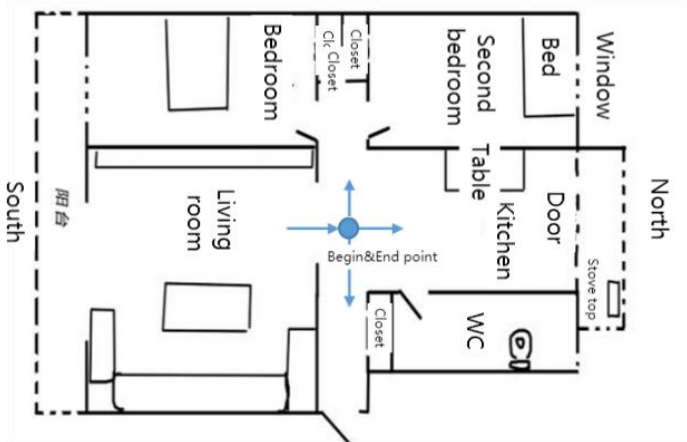

## Outdoor Environment

In case of outdoor environment, in addition to finding multi-path locations and planning closed routes, it is necessary to ensure that the object under test is within the effective measurement range of the scanner (the distance varies due to different reflectivity of the ground).



### Notice!

- A multi-path location is a location that can be reached from multiple directions.

## Closed Loop

### U-shaped Closed Route

The slender closed route is similar to a U-shaped route. The U-shaped route can barely meet the accuracy requirements. If conditions permit, users are advised not to choose this route

### Single Closed O-shape Route

The trajectory shape is similar to O-shaped without redundant closed circles, and the accuracy of data calculation is good, which is one of the most basic requirements for route selection.

### Multi-closed O-shaped Route

The overall trajectory is similar to O-shaped, with multiple closed circles, and the data calculation accuracy is the best. It is composed of multiple closed O-shaped routes, which greatly improves the data calculation accuracy and is the best route planning.

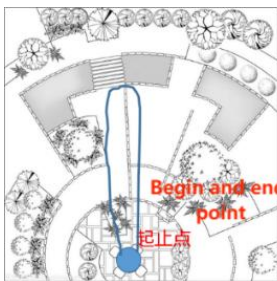

Typical U-Type Route

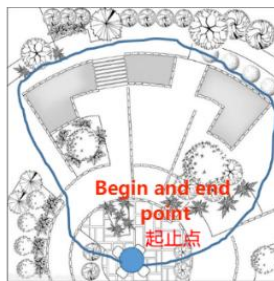

Single Close O-Type Route

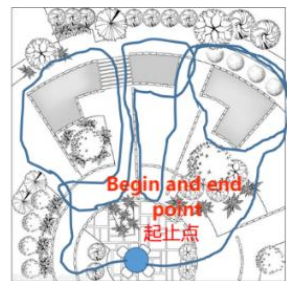

Multiple Close O-Type Route

The SLAM200E scanner can acquire point cloud data with the FOV of  $360^\circ \times 270^\circ$ , and the point density decreases with increasing measurement distance. The data

acquisition process should ensure that the equipment is stable and avoid violent shaking, and avoid pedestrians, vehicles and other non-measurement objects from blocking the front of the equipment for a long time, in order to ensure the integrity of data acquisition.

### Precautions When Passing through the Door

When passing through an interior door with the scanner in hand, it is recommended to pass slowly sideways to ensure the relative stability of the scanner and to ensure that the door is open as much as possible. If the door is closed, when approaching the door you need to turn the scanner back to the door and open the door with the other hand. When passing the door, you must fully consider the scanning field of view and scan as many scenes outside the door as possible in the room, try to avoid the scanner from scanning the moving door, and prevent data calculation errors.

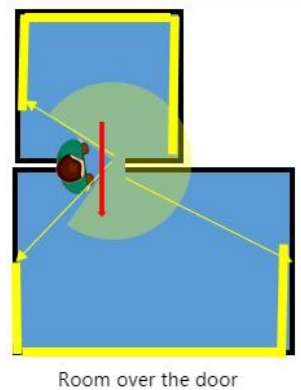

## Precautions When Cornering

When the handheld scanner passes the corner, it is recommended to avoid turning the corner too fast, and the cornering method needs to be considered in route planning. Get as much point cloud data as possible from the same position before and after the corner to improve the data solving accuracy.

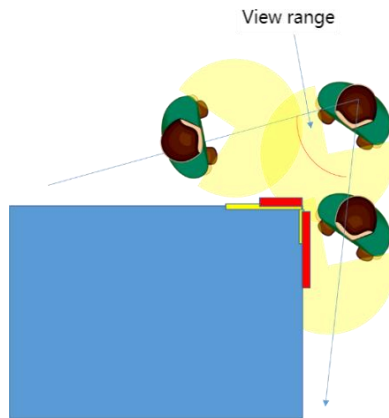

## Precautions for Large-area Data Acquisition

When using the scanner for large-scale data acquisition, the overall survey area should be divided in order to facilitate data interpretation efficiency, improve interpretation accuracy and facilitate survey area management. Divide a large survey area into several small survey areas. It is recommended that the data acquisition time for each survey area planning be controlled within 25 minutes. When multiple sets of data collection need to be spliced, at least 3 common control points are required for two adjacent sets of data and they are not on a straight line.

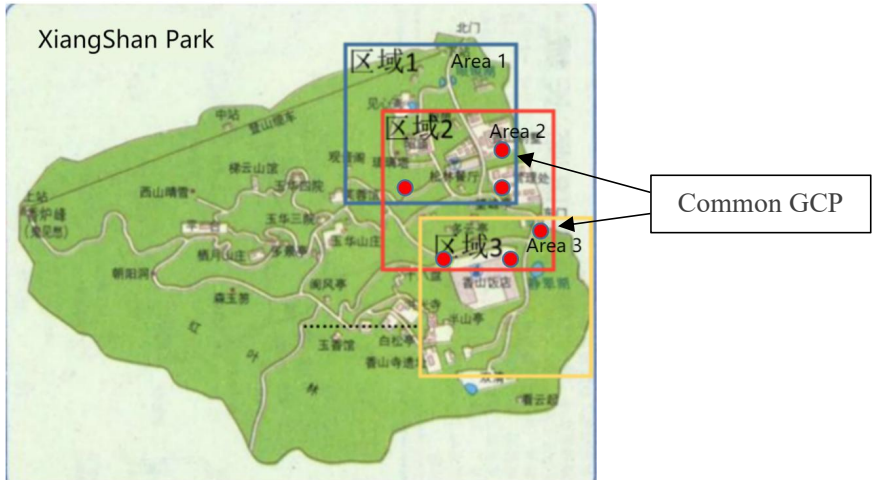

## Strip Control Point Edging

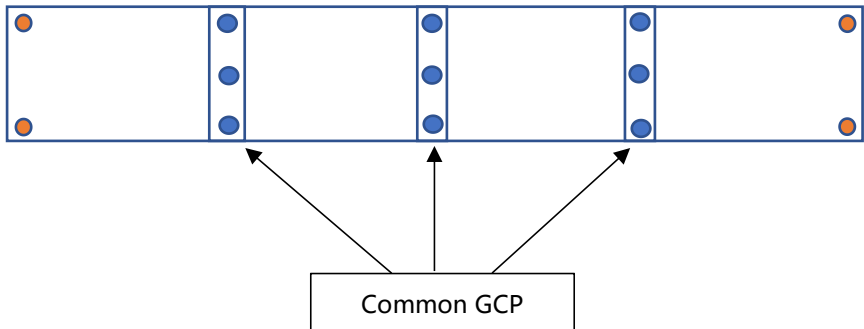

### Caution

- Recommends users to press the on/off key briefly to put the scanner into standby mode after completing a single data acquisition, and then press the on/off key briefly again to start the next data acquisition.
- In principle, it is not required to take a closed-loop path, but in order to guarantee data accuracy, it is recommended that users try to take a complete closed-loop route if conditions permit.
- Please be careful when removing the scanner from the equipment case and take care to protect the rotating laser head ( Precision Parts).
- Do not touch the protective cover of the laser emitting area with your hands.
- Do not touch the camera lens with your hands.
- The laser head is prohibited to be downward during data acquisition.
- Please try to keep the scanner moving smoothly during data collection and avoid violent shaking.
- Before using the device, please make sure that the battery handle is installed in place without loosening, and that the safety catch springs back into place.
- During the use of the equipment, it should be taken care of and put down

gently to avoid damage to the laser due to bumping or violent vibration.

- The single data acquisition time should be more than 60 seconds.
- In order to ensure data security and data processing ease of use it is recommended that the single data acquisition time is controlled within 25 minutes.
- Keep the distance between the scanner and the object to be measured  $> 0.4\text{m}$ , and avoid turning the laser head towards the wall at close range ( $< 0.4\text{m}$ ).
- Try to avoid moving pedestrians in front of the laser head.
- Avoid unnecessary large turns in place.
- Data collection needs to be continuous and ensure a certain degree of overlap.

## Cleaning & Maintenance

### Notice!

- When cleaning the laser head protector and the camera lens can be cleaned using a clean air blow or soft dry soft bristle brush or special cleaning cloth to wipe the surface, do not use alkaline cleaners for cleaning, be careful not to be scratched by hard objects lens glass.

## Storage Requirement

- Keep away from magnetic fields.
- Protect against falling.
- Prevent crushing.
- Keep away from humid environments.

If the device is not used for a long time, please store SLAM200E in a safe, dry and ventilated place that avoids direct sunlight, the storage environment requires a relative humidity of less than 40%, and a temperature of  $-20^{\circ}\text{C} \sim +60^{\circ}\text{C}$  to avoid

excessive humidity in the environment that causes the device to produce condensation, and the recommended storage temperature is +5 ~ +28°C.

※ ※This manual is subject to change without notice.

## Contact Us

If you have any questions or suggestions about the manual, please contact us via:  
e-mail: [aftersales@feimarobotics.com](mailto:aftersales@feimarobotics.com)







[www.feimarobotics.com](http://www.feimarobotics.com)